

TASCAM

TEAC Professional Division

D00951210A

2488MKII

Digital Portastudio

OWNER'S MANUAL

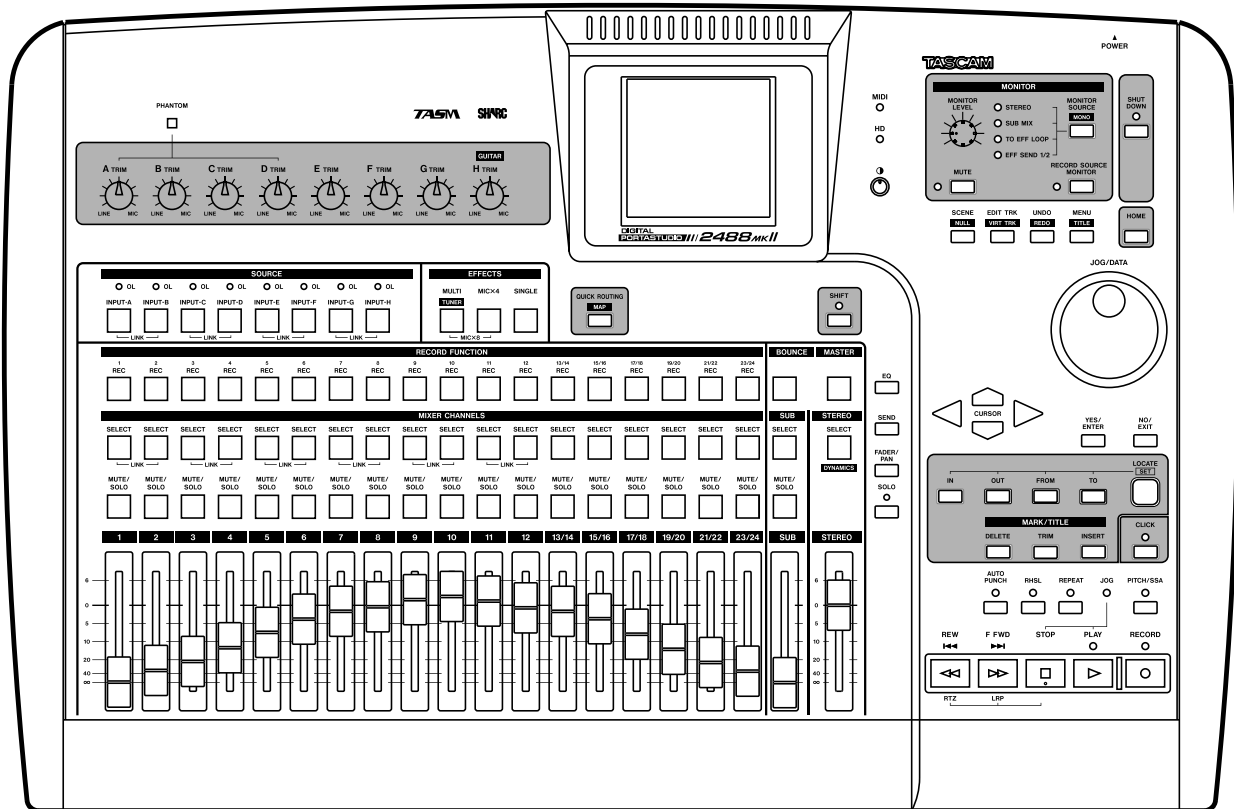

IMPORTANT SAFETY PRECAUTIONS



CAUTION
RISK OF ELECTRIC SHOCK
DO NOT OPEN



CAUTION: TO REDUCE THE RISK OF ELECTRIC SHOCK, DO NOT REMOVE COVER (OR BACK). NO USER-SERVICEABLE PARTS INSIDE. REFER SERVICING TO QUALIFIED SERVICE PERSONNEL.



The lightning flash with arrowhead symbol, within equilateral triangle, is intended to alert the user to the presence of uninsulated "dangerous voltage" within the product's enclosure that may be of sufficient magnitude to constitute a risk of electric shock to persons.



The exclamation point within an equilateral triangle is intended to alert the user to the presence of important operating and maintenance (servicing) instructions in the literature accompanying the appliance.

This appliance has a serial number located on the rear panel. Please record the model number and serial number and retain them for your records.

Model number _____

Serial number _____

WARNING: TO PREVENT FIRE OR SHOCK HAZARD, DO NOT EXPOSE THIS APPLIANCE TO RAIN OR MOISTURE.

For U.S.A.

TO THE USER

This equipment has been tested and found to comply with the limits for a Class B digital device, pursuant to Part 15 of the FCC Rules. These limits are designed to provide reasonable protection against harmful interference in a residential installation. This equipment generates, uses, and can radiate radio frequency energy and, if not installed and used in accordance with the instruction manual, may cause harmful interference to radio communications.

However, there is no guarantee that interference will not occur in a particular installation. If this equipment does cause harmful interference to radio or television reception, which can be determined by turning the equipment off and on, the user is encouraged to try to correct the interference by one or more of the following measures.

- a) Reorient or relocate the receiving antenna.
- b) Increase the separation between the equipment and receiver.
- c) Connect the equipment into an outlet on a circuit different from that to which the receiver is connected.
- d) Consult the dealer or an experienced radio/TV technician for help.

CAUTION

Changes or modifications to this equipment not expressly approved by TEAC CORPORATION for compliance could void the user's authority to operate this equipment.

IMPORTANT SAFETY INSTRUCTIONS

- 1 Read these instructions.
 - 2 Keep these instructions.
 - 3 Heed all warnings.
 - 4 Follow all instructions.
 - 5 Do not use this apparatus near water.
 - 6 Clean only with dry cloth.
 - 7 Do not block any ventilation openings. Install in accordance with the manufacturer's instructions.
 - 8 Do not install near any heat sources such as radiators, heat registers, stoves, or other apparatus (including amplifiers) that produce heat.
 - 9 Do not defeat the safety purpose of the polarized or grounding-type plug. A polarized plug has two blades with one wider than the other. A grounding type plug has two blades and a third grounding prong. The wide blade or the third prong are provided for your safety. If the provided plug does not fit into your outlet, consult an electrician for replacement of the obsolete outlet.
 - 10 Protect the power cord from being walked on or pinched particularly at plugs, convenience receptacles, and the point where they exit from the apparatus.
 - 11 Only use attachments/accessories specified by the manufacturer.
 - 12 Use only with the cart, stand, tripod, bracket, or table specified by the manufacturer, or sold with the apparatus. When a cart is used, use caution when moving the cart/apparatus combination to avoid injury from tip-over.
- Do not expose this apparatus to drips or splashes.
 - Do not place any objects filled with liquids, such as vases, on the apparatus.
 - Do not install this apparatus in a confined space such as a book case or similar unit.
 - The apparatus draws nominal non-operating power from the AC outlet with its POWER switch in the off position.
 - The apparatus should be located close enough to the AC outlet so that you can easily grasp the power cord plug at any time.
 - An apparatus with Class I construction shall be connected to an AC outlet with a protective grounding connection.
 - Batteries (battery pack or batteries installed) should not be exposed to excessive heat such as sunshine, fire or the like.



- 13 Unplug this apparatus during lightning storms or when unused for long periods of time.
- 14 Refer all servicing to qualified service personnel. Servicing is required when the apparatus has been damaged in any way, such as power-supply cord or plug is damaged, liquid has been spilled or objects have fallen into the apparatus, the apparatus has been exposed to rain or moisture, does not operate normally, or has been dropped.

Safety Information

This product has been designed and manufactured according to FDA regulations “title 21, CFR, chapter 1, subchapter J, based on the Radiation Control for Health and Safety Act of 1968, ” and is classified as a class 1 laser product. There is no hazardous invisible laser radiation during operation because invisible laser radiation emitted inside of this product is completely confined in the protective housings.

The label required in this regulation is shown at ①.

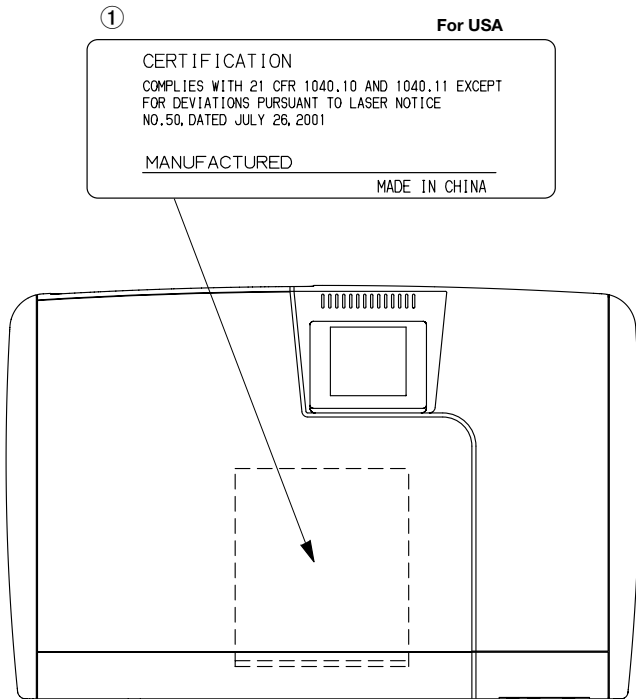

CAUTION

- DO NOT REMOVE THE PROTECTIVE HOUSING USING A SCREWDRIVER.
- USE OF CONTROLS OR ADJUSTMENTS OR PERFORMANCE OF PROCEDURES OTHER THAN THOSE SPECIFIED HEREIN MAY RESULT IN HAZARDOUS RADIATION EXPOSURE.
- IF THIS PRODUCT DEVELOPS TROUBLE, CONTACT YOUR NEAREST QUALIFIED SERVICE PERSONNEL, AND DO NOT USE THE PRODUCT IN ITS DAMAGED STATE.

Optical pickup:

Type: SF-W37S

Manufacturer: SANYO

Laser output: 1.5 mW (Read), 74 mW (White)

Wavelength: 783 nm

1 – Introductions.....	8
Supplied accessories	8
Use with a personal computer.....	8
About this User's Manual.....	9
Manual conventions	9
Precautions and notes for placement and use	10
Handling of compact discs.....	10
Beware of condensation	10
Never use a stabilizer or printable discs.....	10
About CD-R and CD-RW discs.....	11
About finalizing	11
2 – Setting up and basic knowledge	12
Setting up the 2488MKII	12
Shutdown.....	13
Basic knowledge.....	13
Hard disk and partitions	13
Selecting the active partition.....	13
Songs.....	14
Screen	14
Menu screen	14
Home screen	14
Direct access screens	15
Some general notes on using the 2488MKII.....	15
Navigation.....	15
YES/ENTER key.....	15
NO/EXIT key	15
Changing values	15
Titling	15
SHIFT key.....	16
3 – Names and functions of the 2488MKII.....	17
Top panel.....	17
Input channel section.....	17
Effects section	18
Track mixer section.....	18
Sub mixer section	18
Stereo Bus section	18
Monitor Section.....	19
LCD display section	19
Access indicator section	19
Utility section.....	19
Screen operation section	19
Channel section	20
Locate section	20
Mark/Title section	20
Transport section.....	21
Transport keys	21
Mixdown section.....	21
Routing section.....	22
Other keys.....	22
Front panel	22
Rear panel	23
4 – Recording	24
Setting up your first song.....	24
New song	24
Setting the tempo	25
Making the first recording.....	26
Recording the guitar	26
Lead line	28
5 – Mixer.....	29
Inputs and assignments	29
Assignment to a stereo track	29
Digital input assignment	29
Checking assignments.....	30
Breaking assignments.....	30
Saving and loading assignments (QUICK ROUTING)	30
Channel functions	31
Track channels and input channels	31
EQ.....	31
Digital pad/gain.....	31
EQ.....	31
Effect send	32
Fader/pan	32
Phase	32
Pan	32
Faders	32
Mute	33
Linking channels.....	33
Stereo bus functions.....	33
Stereo EQ	33
Stereo dynamics	34
Stereo fader	34
Direct output	35
Sub mixer.....	35
Monitoring.....	36
Monitor selection	36
Mono monitoring	36
Record source monitoring	36
Monitor muting	36
Soloing and toggle.....	37
Scene memories	37
Scene recall	37
Internal faders and physical faders	37
Fader matching	37
Saving scenes.....	38
Matching the physical faders with internal fader values.....	38
6 – Effects.....	39
Settings insert effect modes	39
Mic effects	39

Contents

Assigning mic effects	39
Selecting mic effects	40
Editing mic effects.....	40
Multi-effect.....	41
Assigning the multi-effect.....	41
Editing the multi-effect	41
Using the multi-effect library.....	41
Saving multi-effect settings	42
Single effect	42
Saving single effects	42
Tuner.....	43
7 – Recorder	44
First steps in recording (song management)	44
Creating a song.....	44
Loading a song	44
Saving a song.....	45
Reverting to the previously saved version of a song	45
Erasing a song.....	45
Copying songs	46
Erasing unneeded audio data from songs ...	46
Protecting a song	47
Transport controls.....	47
Setting the playback position	47
Return to zero (RTZ).....	47
Last Recording Position (LRP)	47
Jog positioning	48
Fast forward and rewind	49
Skipping to marks.....	49
Recording.....	49
PUNCH recording.....	49
Hands-free recording	50
Undo recordings	50
Rehearsing recording	50
IN, OUT, TO and FROM points	50
Setting the IN, OUT, TO and FROM points ...	50
Locating to the points.....	50
Editing the IN, OUT, TO and FROM points ...	51
Mark functions	51
Inserting marks.....	51
Active marks	51
Giving a title to the active mark	51
Deleting the active mark	51
Editing the active mark	52
Skip between marks.....	52
Using the mark list	53
Locating using the list.....	53
Titling using the list	53
Erasing marks using the list.....	53
Direct location	54
Direct location (i).....	54
Direct location (ii).....	54
Repeat	55
Setting the repeat interval	55
Auto punch operations.....	55
Setting the punch points	56
Checking the punch points	56
Rehearsing the punch	56
Recording the punch	57
Checking the take.....	57
After finishing the punch	57
If you change your mind.....	57
Bouncing tracks.....	58
Making a bounce mix.....	58
About track editing.....	58
IN, OUT, TO and FROM.....	59
Entering the edit mode.....	59
Track editing functions	59
COPY → PASTE.....	60
COPY FROM → TO	60
COPY → INSERT	61
MOVE → PASTE	61
MOVE → INSERT	62
OPEN.....	62
CUT	62
SILENCE	63
CLONE TRACK	63
CLEAN OUT	63
UNDO and REDO	64
Undoing and redoing actions.....	64
An undo/redo example	65
Virtual tracks	66
Varispeed operations (pitch and SSA)..	68
Pitch	68
SSA (Slow Speed Audition).....	68
8 – Mastering and CD recorder	69
Pre-mastering	69
Recording the master track	69
Exiting pre-mastering mode.....	69
Checking the master.....	70
Exiting master check mode.....	70
Trimming the master.....	70
Copying the master track	70
Creating an audio CD.....	71
Creating an audio CD using TAO.....	71
Finalizing the disc.....	72
Creating an audio CD using DAO	72
Creating an audio CD using Live Writer	73
Playing CDs	74
CD-RW erase	74
CD EJECT.....	74
9 – Reformatting.....	75
Reformatting the entire hard disk	75

Reformatting TASCAM partitions.....	76	Specifications	96
Reformatting the FAT partition	76	Audio connections.....	96
10 – File import/export.....	77	Audio performance	96
USB mode	77	Physical specifications, etc.....	97
Opening the USB connection	77	Dimensional drawing.....	97
Closing the USB connection.....	77	Appendix	98
USB import (mono WAV files)	78	MIDI Control/Program change	
USB import (stereo WAV files)	78	message.....	98
USB import (SMF files)	79	Mixer Control Change parameters.....	98
USB export (virtual tracks)	80	Effect parameter change MIDI messages.....	99
Exporting master tracks	81	Example effect parameter change.....	99
Importing from CD (mono WAV files) ..	81	Mic effects.....	100
Exporting to CD (virtual tracks).....	82	Stereo dynamics processor	101
11 – Backup and restoration	83	Single effect.....	101
Backup.....	83	Multi effect	102
Restoring from CD	84	MIDI Program Change messages	105
Using USB for backup and restore	84	Scene memory Program Change messages..	105
Backing up.....	85	Preset mic effects	106
Restoring.....	86	Preset stereo dynamics effects	106
12 – Tempo and MIDI	87	Preset Multi effects	106
Metronome	87	Preset single effects	107
Using the metronome	87	MIDI Implementation chart	108
In FREE mode	87	MMC Bit map commands	109
In REC mode or REC&PLAY mode.....	88	Bit-map array of MMC commands	109
Tempo map	88	Bit-map array of Response/ Information field.....	110
Setting the tempo	88	Warning and status messages	111
Time signature setting	88		
MIDI synchronization.....	89		
MIDI clock.....	89		
SMF playback.....	90		
MIDI remote control	91		
MMC MODE	91		
MMC Device ID	91		
REMOTE CONTROL.....	91		
13 – General preferences.....	92		
Global preferences.....	92		
Key sense time.....	92		
Meter peak hold mode	92		
Meter release time	92		
Shift key behavior	92		
Mixer preferences	92		
Fader matching	92		
Digital input channel selection	93		
Recorder preferences.....	93		
User words.....	93		
14 – Specifications, etc.	94		
Block diagram.....	94		
Level diagram	95		

1 – Introductions

Thank you for purchasing the 24-track TASCAM 2488MKII Digital Portastudio. With this all-in-one digital multitrack recorder, you can record, mix and master audio on an 80GB hard disk and make audio and backup CDs with the internal CD-RW drive.

Before connecting and using the unit, please read this User's Guide carefully before operating the unit. After you have finished reading this manual, please keep it in a safe place for future reference.

Main features of the 2488MKII

- 80GB hard disk
- Easy song management using multiple partitions
- 24-track digital recorder
- Records uncompressed audio at a sampling frequency of 44.1 kHz at 16 or 24 bit resolution
- Simultaneously records up to 8 tracks and plays back up to 24 tracks for mixing
- Stores up to 250 virtual tracks in each song
- Mixer with 24 playback track channels and 8 input channels
- 4 XLR mic inputs with phantom power
- High impedance inputs for guitar
- 3-band EQ and numerous internal effects for use on every track and input channel
- Internal CD-RW drive for burning discs
- Mic effects and multi-effect (for guitar) that can be used as insert effects; single effect that can be used in an effect loop
- MIDI Time Code and MIDI Clock synchronization possible
- Exchange WAV and SMF files with personal computers

About Copyright and Liability

This product is designed to help you record and reproduce sound works to which you own the copyright, or where you have obtained permission from the copyright holder or the rightful licensor. Unless you own the copyright, or have obtained the appropriate permission from the copyright holder or the rightful licensor, your unauthorized recording, reproduction or distribution thereof may result in severe criminal penalties under copyright laws and international copyright treaties. If you are uncertain about your rights, contact your legal advisor. Under no circumstances will TEAC Corporation be responsible for the consequences of any illegal copying performed using the 2488MKII.

Windows, Windows XP, and Windows 2000 are trademarks of Microsoft Corporation. Macintosh, Mac OS, and Mac OS X are trademarks of Apple Computer. All other trademarks are the property of their respective holders.

TASCAM shall bear no liability if a user should experience indirect damages (for example, the customer is unable to realize a benefit for some reason) or secondary damages (loss of recorded data, etc.) during the use of this unit.

NOTE

Misuse or malfunction of the device may result in loss of recorded data. We recommend that you back up important data on a computer hard disk, CD-R/CD-RW or other storage media.

Supplied accessories

In addition to this manual, the 2488MKII has been packed with the following:

- AC power cable 1
- Warranty card..... 1

Contact your TASCAM supplier if any of these items are missing.

NOTE

We recommend that you keep the original box and packing materials for transportation of this unit.

Close the disc tray during transportation.

Use with a personal computer

To import and export files and back up data, connect the 2488MKII to a personal computer using a USB connection. Data transmission occurs at high speed if the computer connection and cable are USB 2.0 compatible. Transmission occurs at a slower speed with equipment that is only USB 1.1 compatible. Please see your computer's documentation for more information.

We recommend using a cable designed for USB 2.0 to assure accurate and fast transmission of data.

This unit can be connected to computers using one of the following operating systems.

- Microsoft: Windows 2000, Windows XP
- Apple: Mac OS 9.2, Mac OS X 10.2 or later

NOTE

If you are using Mac OS 9.0x or 9.1x, we recommend upgrading to OS 9.2 or later. Drivers are unnecessary. The unit will appear as a removable disc.

About this User's Manual

This User's Manual is comprised of the following chapters.

1 – Introductions (page 8)

In addition to an overview of the unit and information about CD-R/CD-RW discs and other features, this chapter explains the structure of this User's Guide and describes the conventions used in it. This chapter also includes important notices about copyright and liability.

2 – Setting up and basic knowledge (page 12)

Read this chapter before operation. This explains setup, startup, shutdown, and other basic knowledge necessary to use the unit.

3 – Names and functions of the 2488MKII (page 17)

This chapter explains the functions of the control keys and knobs on the top panel of this unit, the connection jacks and other parts.

4 – Recording (page 24)

The example in this chapter explains the basic functions needed to use the 2488MKII to make recordings.

5 – Mixer (page 29)

This chapter explains the 2488MKII's extensive mixer functions, including input assignment, EQ and effect sends, as well as scene memory and other functions that are useful in regular operation.

6 – Effects (page 39)

This 2488MKII includes three types of digital effects – mic insert effects, guitar insert effects, and a single effect useful at mixdown. This chapter explains these effects and how to use them in detail.

7 – Recorder (page 44)

The 2488MKII's 24-track recorder has numerous advanced functions, including mark points, auto punch recording (including rehearsal functions), undo/redo and virtual tracks. This chapter explains these recorder functions in detail and how to use them.

8 – Mastering and CD recorder (page 69)

This chapter explains the procedures for creating a stereo master track after recording and the procedures for making audio CDs using the internal CD recorder. It also covers other CD recorder functions.

9 – Reformatting (page 75)

This chapter explains how to reformat the entire internal hard disk or specific partitions.

10 – File import/export (page 77)

This chapter explains file import and export. Audio data files can be imported and exported between this unit's internal hard disk and a connected personal computer, or between the internal hard disk and a CD-R/CD-RW disc. SMF files can also be imported.

11 – Backup and restoration (page 83)

This chapter explains backup and restoration of song data. This unit can back up and save song data to CD-R/CD-RW discs and connected computers. The data in these files can later be restored to this unit for further use.

12 – Tempo and MIDI (page 87)

This chapter explains the unit's tempo management functions (tempo map, metronome) and MIDI functions (synchronization, SMF playback, mixer/effect control).

13 – General preferences (page 92)

This chapter explains the preference settings and how to adjust them according to your project conditions.

14 – Specifications, etc. (page 94)

This section includes electrical and mechanical specifications and block and level diagrams.

Appendix (page 98)

This part provides additional information, including details of MIDI messages used to control this unit and a list of warning messages.

Manual conventions

In this manual, we use the following conventions:

- Controls and indicators on the 2488MKII are written like this: **HOME**.
- Inputs and controls of other equipment are written like this: **AUX IN**.
- Messages shown on the display are written like this: `Are you sure?`.
- If a preset indicator (i.e. one which cannot change) is shown, it is written like this: **TEMPO**.

- We use the term “soft switch” or “button” to describe an on/off control on the display. Also note the difference between “disc” and “disk.” When we refer to a disc, we are refer to a CD-R, CD-RW or pre-recorded audio CD. A disk, on the other hand, refers to the 2488MKII's internal hard disk drive, or that of a connected computer.
- We use the term “key” to describe a push-button control on the 2488MKII's surface.

1 – Introductions

Precautions and notes for placement and use

The 2488MKII may be used in most areas, but to maintain top performance, and prolong operating life, observe the following notes, precautions and environmental conditions:

- Avoid exposing it to extremes of temperature and humidity and avoid mechanical shocks and vibration.
- Keep the unit away from strong magnetic fields (TV sets, computer monitors, large electric motors, etc.).
- The nominal temperature should be between 5°C and 35°C (41°F and 95°F).

- Relative humidity should be 30 to 80 percent.
- As the unit may become hot during operation, always leave sufficient space above the unit for ventilation. Do not install this unit in a confined space such as a bookcase, and do not put anything on top of the unit.
- Avoid installing this unit on top of any heat-generating electrical device such as a power amplifier.
- Make sure that the unit is mounted in a level position for correct operation.

Handling of compact discs

The 2488MKII has been designed for the playback of CD-DA (standard audio) format discs.

- Always place the compact discs in the trays with their label facing upward.
- To remove a disc from its case, press down on the center of the disc holder, then lift the disc out, holding it carefully by the edges.

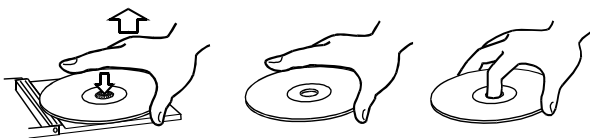

- Avoid getting fingerprints on the signal side (the non-label side). Grime and dust may cause skipping, so keep discs clean and store them in their cases when not being played. To clean the signal side of a disc, wipe gently with a soft dry cloth from the center towards the outside edge.



- Keep discs away from direct sunlight, and places of high heat and humidity. If left in such places, warping could result.
- Do not use any record spray, anti-static solutions, benzene, paint thinner or other chemical agents to clean CDs as they could damage the delicate playing surface. It may cause CDs to become unplayable.
- Discs should be returned to their cases after use to avoid dirt as well as serious scratches that could cause the laser pickup to skip.
- Do not affix any labels or stickers to the label side of the disc and do not use any protective coating spray.
- Do not insert discs that have adhesive remaining from tape or stickers that have been removed. If they are inserted into the player, they could stick to the internal mechanism, requiring removal by a technician.
- Do not use cracked discs.
- Only use circular compact discs. Avoid using non-circular promotional, etc. discs.

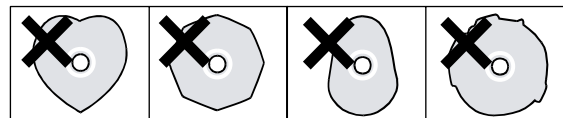

Beware of condensation

If the unit (or a compact disc) is moved from a cold to a warm place, or used after a sudden temperature change, there is a danger of condensation; vapor in the air could condense on the internal mechanism, making correct operation impossible. To prevent this, or if this occurs, let the player sit for one or two hours at the new room temperature before using.

Never use a stabilizer or printable discs

Using commercially available CD stabilizers or printable recordable discs with this player will damage the mechanism and cause it to malfunction.

CAUTION

Never use a disc that has had a stabilizer mounted to it. The residual adhesive may cause the disc to stick to the turntable of the 2488MKII. If it sticks to the turntable, you will need a technician to get it out.

About CD-R and CD-RW discs

CD-R discs can be recorded once only. Once they have been used for recording, they cannot be erased or re-recorded. However, if space is available on the disc, additional material can be recorded. The packaging of CD-R discs will include one of the following logos:

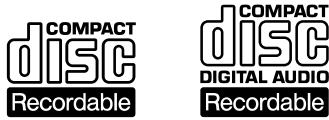

By contrast, a CD-RW disc can be used in much the same way as a CD-R disc, but the last track or tracks recorded can be erased before the disc has been “finalized,” and the space on the disc can be re-used for other recordings. The packaging of CD-RW discs will include the logo one of the following logos:



However, you should note that an audio CD created using a CD-RW disc may not play back satisfactorily on every audio CD player. It will, naturally, be playable on the 2488MKII. This is in no way a limitation of the 2488MKII itself, but of the difference between the different types of media and the methods used to read them.

There are precautions that you should take when handling CD-R and CD-RW discs.

- Avoid touching the recording (non-label) side of a disc on which you will be recording. Recording on a disc requires a cleaner surface than playing back, and fingerprints, grease, etc. can cause errors in the recording process.
- CD-R and CD-RW discs are sensitive to the effects of heat and ultraviolet rays. It is important that they are not stored in a location where direct sunlight will fall on them, and which is away from sources of heat such as radiators or heat-generating electrical devices.

About finalizing

Although audio data may be written on a CD-R or CD-RW disc, a standard CD player will not be able to read the data (i.e. play back the audio) until a final *TOC has been written at the start of the disc.

*TOC: Table of contents

Information of recorded data, which contains titles, starting and ending addresses, and etc..

The process of writing this table of contents is known as “finalizing.” Once this has been done, no further data can be written to the disc. See “Finalizing the disc” on page 72 for details. In the case of a CD-RW disc which has been finalized, the whole of the disc may be erased, or the disc may be “refreshed,” and the disc re-used.

- Always store CD-R and CD-RW discs in their cases to avoid dirt and dust accumulating on their surfaces.
- When labeling CD-R and CD-RW discs, always use a soft oil-based felt-tipped pen to write the information. Never use a ball-point or hard-tipped pen, as this may cause damage to the recorded side.
- Always keep the recording sides of the discs away from grime and dust to avoid a reduction in sound quality. To clean a disc, wipe gently with a soft dry cloth from the center towards the outside edge. Do not use thinner, gasoline, benzene or LP cleaning fluid, as these will damage the disc and cause the disc unplayable.
- Do not put labels or protective sheets on the discs and do not use any protective coating spray.
- If you are in any doubt as to the care and handling of a CD-R and CD-RW discs, read the precautions supplied with the disc, or contact the disc manufacturer directly.

2 – Setting up and basic knowledge

Setting up the 2488MKII

First, find a flat level surface for the 2488MKII which is stable and cannot be jogged or jolted easily.

This should be a hard surface. Do not put the 2488MKII on a carpet or furnishings, as this will block the airflow and possibly cause overheating.

You should avoid moving the 2488MKII while it is switched on.

Especially, you should never move it while the HD indicator by the display is lit or flashing.

Leave a little space at the back of the 2488MKII to plug and unplug microphones, etc.

Before switching on the 2488MKII, you should connect the monitoring system (this term refers to the amplifier and speakers and headphones that you will use to listen to your recordings).

TIP

When you are recording electric guitars and basses, etc., you can listen through speakers. When you are recording using a microphone, this may cause acoustic feedback, so you should use headphones at this time.

Most sound professionals recommend that you do not use headphones for monitoring all the time, even though they are very convenient and useful in some circumstances.

Using the included power cord, connect this unit to a power outlet, ensuring that it is the correct voltage for the unit.

Connect the **MONITOR OUT** jacks on the rear panel to your amplifier's **AUX** inputs (or any inputs except those designed for a record turntable). You will probably need a pair of 1/4"-to-RCA cables for this.

NOTE

The 2488MKII outputs balanced signals from the monitor outputs. If you have an amplifier with balanced inputs, use balanced cables rather than unbalanced cables here.

Plug a standard pair of headphones into the 1/4" **PHONES** jack at the front left of the 2488MKII.

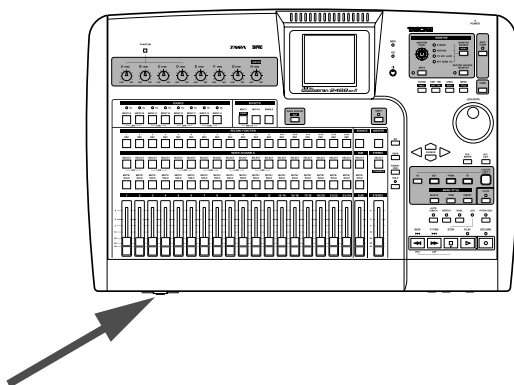

Plug in and turn on the 2488MKII. The power switch is on the rear, by the power cord.

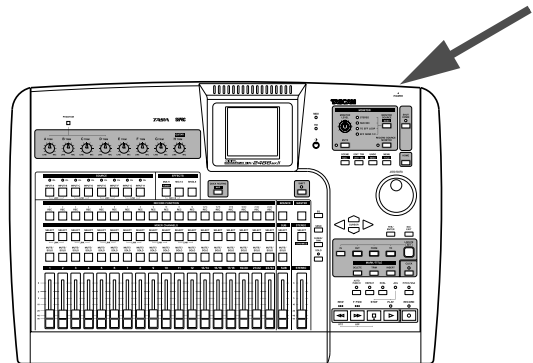

The display shows the following startup screen and the HD (hard disk) indicator light blinks.

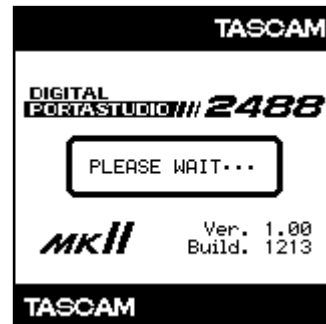

After about 20 seconds, the 2488MKII will be ready and the HD (hard disk) indicator stops flashing. Adjust the display so that it is comfortable for you to read, using the contrast control.

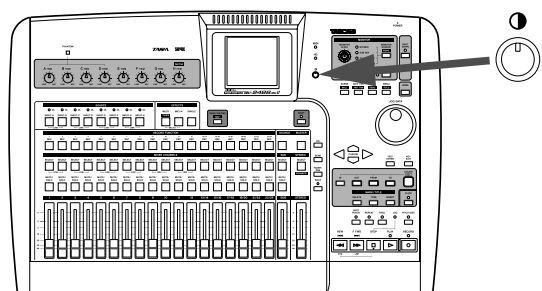

2 – Setting up and basic knowledge

Shutdown

You should always use the **SHUT DOWN** key before turning off the 2488MKII.

The 2488MKII contains a hard disk which is used to store your song data. If you simply turn off the unit using the power switch, there may be some data in the 2488MKII's memory which hasn't been written to disk and you will therefore lose that data when you turn off the unit.

- 1 Press and hold down the **SHUT DOWN** key for two or three second. The red indicator lights, and the display shows an message `Are you sure?`.

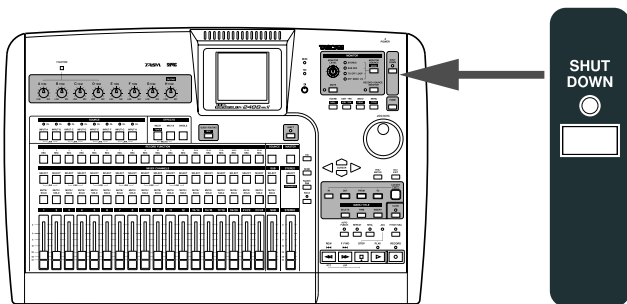

- 2 Press the **YES/ENTER** key. The **HD indicator (orange)** flashes as data is written to the hard disk (the display also shows this process).

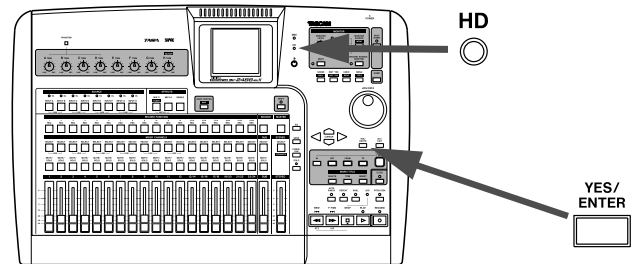

When all data is written to the hard disk, the **SHUT DOWN** indicator flashes red. The display shows `SHUT DOWN COMPLETE`.

- 3 Use the power switch at the rear of the 2488MKII to turn off the unit.

Basic knowledge

Before using this unit, please read and understand the fundamental principles explained in this section

Hard disk and partitions

This unit records audio data and other song information on an 80GB internal hard disk that is divided into multiple partitions. The so-called "FAT partition" is an 8GB partition in FAT-32 format dedicated to file exchange. This partition is used to exchange files between the unit and a computer connected by USB, and cannot be used for recording or playback. This partition can only be accessed: when using a USB connection for backup and restoration operations, WAV file import and export, and SMF import.

The rest of the hard disk is divided into multiple partitions for storing songs. Since these partitions use TASCAM's own format, they are named "TASCAM partitions." The

sizes of these partitions are set when they are created. The maximum number of TASCAM partitions is four (see "Reformatting TASCAM partitions" on page 76).

Choose the partition that you want to work in by using the **SELECT** item in the **DISK** menu. The selected partition is the "active" partition. Only one partition can be active at a time. Inactive partitions cannot be accessed until you make them active.

Selecting the active partition

Select a partition using these procedures.

- 1 With the transport stopped, press the **MENU** key. The **MENU** screen appears.

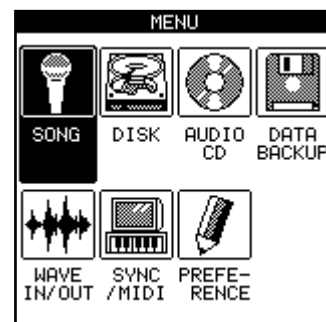

2 – Setting up and basic knowledge

- Turn the JOG/DATA dial until the DISK item is highlighted, and then press the YES/ENTER key.

The DISK menu appears.

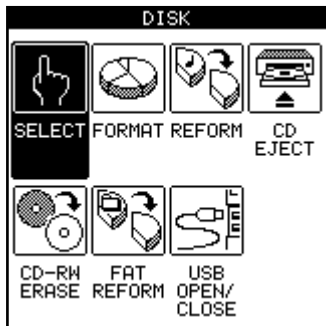

- Use the JOG/DATA dial until the SELECT item is highlighted, and then press the YES/ENTER key.

The partition list appears on the screen. The open space in each partition appears on the right.

SELECT	
PARTITION	FREE
↑ Part01	10284 MB
● Part02	11314 MB
Part03	8341 MB
↓ Part04	9423 MB

- Use the JOG/DATA dial until the partition you wish to use is highlighted, and then press the YES/ENTER key.

The partition is now selected.

Songs

When using the 2488MKII, the term “song” refers to all the data related to the recording, playback, editing, and other work in a single project. Each song includes recorded audio data, and a “playlist” (playback procedures for audio data), track and mark point information, and settings for the mixer, effects, MIDI, tempo and pitch control. This information is never shared between different songs.

Each partition can contain a maximum of 250 songs, and each song can be given a name.

You must select a song by creating a new song, or loading an existing song before you can do any work with the 2488MKII.

Save the song when you finish working. See “First steps in recording (song management)” on page 44 for more details.

NOTE

When you change the active partition (see “Selecting the active partition” on page 13) the most recently used song in the newly active partition is loaded.

Screen

■ Menu screen

You make many of the settings for this unit from the menu screen. With the transport stopped, press the MENU key to display the MENU screen. Use the cursor keys or the JOG/DATA dial to select the desired menu, and then press the YES/ENTER key.

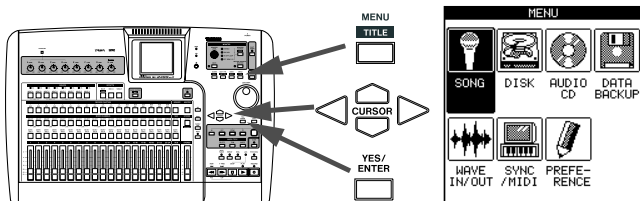

NOTE

Some keys, including the transport keys, do not function when the MENU screen is shown.

■ Home screen

This screen shows the main information related to recording. Press the HOME key to display the home screen, which shows track levels, current song position, song name, remaining recordable time (minutes) and other information.

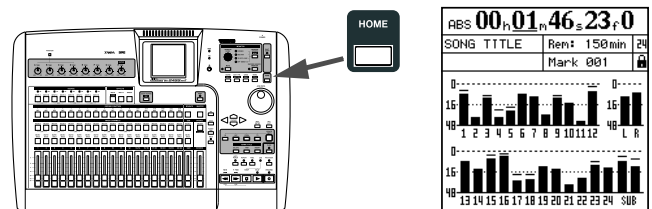

2 – Setting up and basic knowledge

■ Direct access screens

The keys listed below are keys dedicated to various functions and many allow direct access to related screens. Some of these keys, however, do not have dedicated screens for editing. Please see the related section for each function for details.

- Channel section (page 20)
- Sub mixer section (page 18)
- Stereo bus section (page 18)
- Mixdown section (page 21)
- Effects section (page 18)
- Utility section (page 19)
- Routing section (page 22)
- Locate section (page 20)

Some general notes on using the 2488MKII

■ Navigation

To navigate inside the 2488MKII screens, use the **CURSOR** keys to move the cursor.

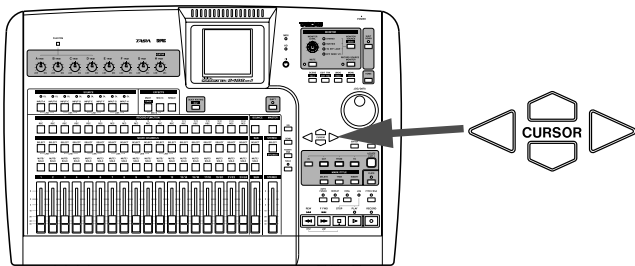

■ Changing values

Use the **JOG/DATA** dial (we'll just call it "the dial") to increase or decrease values shown on the screen.

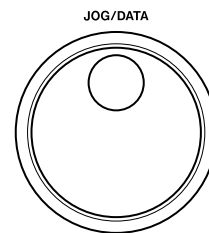

■ YES/ENTER key

To do an action, to enter a sub-menu or to answer "yes" to a question. We will often refer to this as just the **YES/ENTER** key.

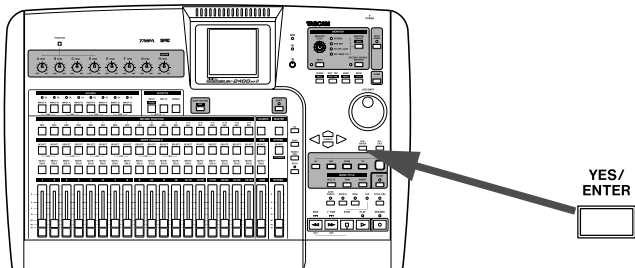

■ Titling

With the **SHIFT** indicator lit, press the **TITLE** key to set or edit the title of one of these objects. A pop-up appears allowing you to edit the title:

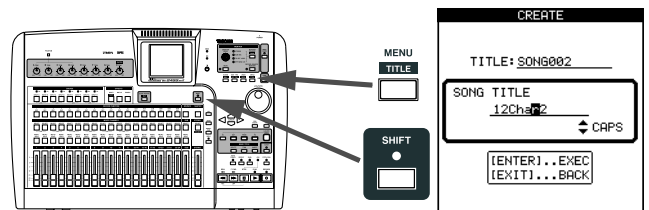

Use the left and right cursor keys to move around inside the title, and the dial to select a character at the cursor position. Use the **INSERT** and **DELETE** keys to insert and delete characters at the cursor position.

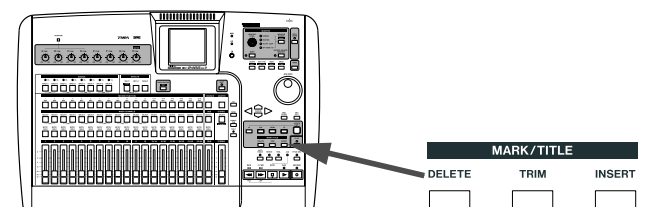

■ NO/EXIT key

To do the opposite of confirming (that is, to leave a screen without performing an action, to go up a menu level, or to answer "no" to a question). We will often refer to this as just the **NO/EXIT** key.

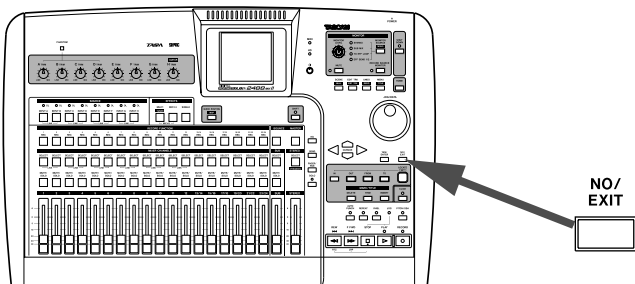

You can also use the up and down cursor keys as "shift" keys, allowing you to select between:

- CAPS—uppercase CAPITAL LETTERS
- small—lowercase small letters
- NUM—numbers
- WORD—you can use the dial to select from a range of preset words (VERSE, CHORUS, etc.). The preset words can be edited to meet your needs, as described in "User words" on page 93.

2 – Setting up and basic knowledge

SHIFT key

Many keys have two functions: the first is written in normal (white) type, and the second is written under this in white on a green background.

To access these second shifted functions:

- 1 Press the SHIFT key so that the indicator lights.

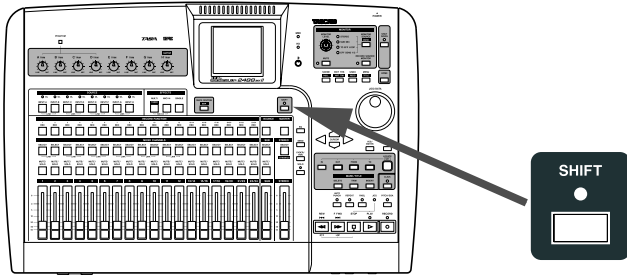

- 2 Press the key whose second function you want to use. The SHIFT indicator goes out.

NOTE

As the 2488MKII is shipped from the factory, if you press the SHIFT key and do not press another key within a second or so, the SHIFT indicator goes out. This prevents you from accessing unwanted functions by accident. If you hold down the SHIFT key while you are looking for the next key, it will stay on.

You can change this behavior so that the SHIFT key becomes a non-latching key—that is, you have to press and hold it while you are pressing the other key, or a latching key that stays on until the other key is pressed. See “Shift key behavior” on page 92 for details of how to make this change.

Several shifted functions are not indicated on the panel.

3 – Names and functions of the 2488MKII

Top panel

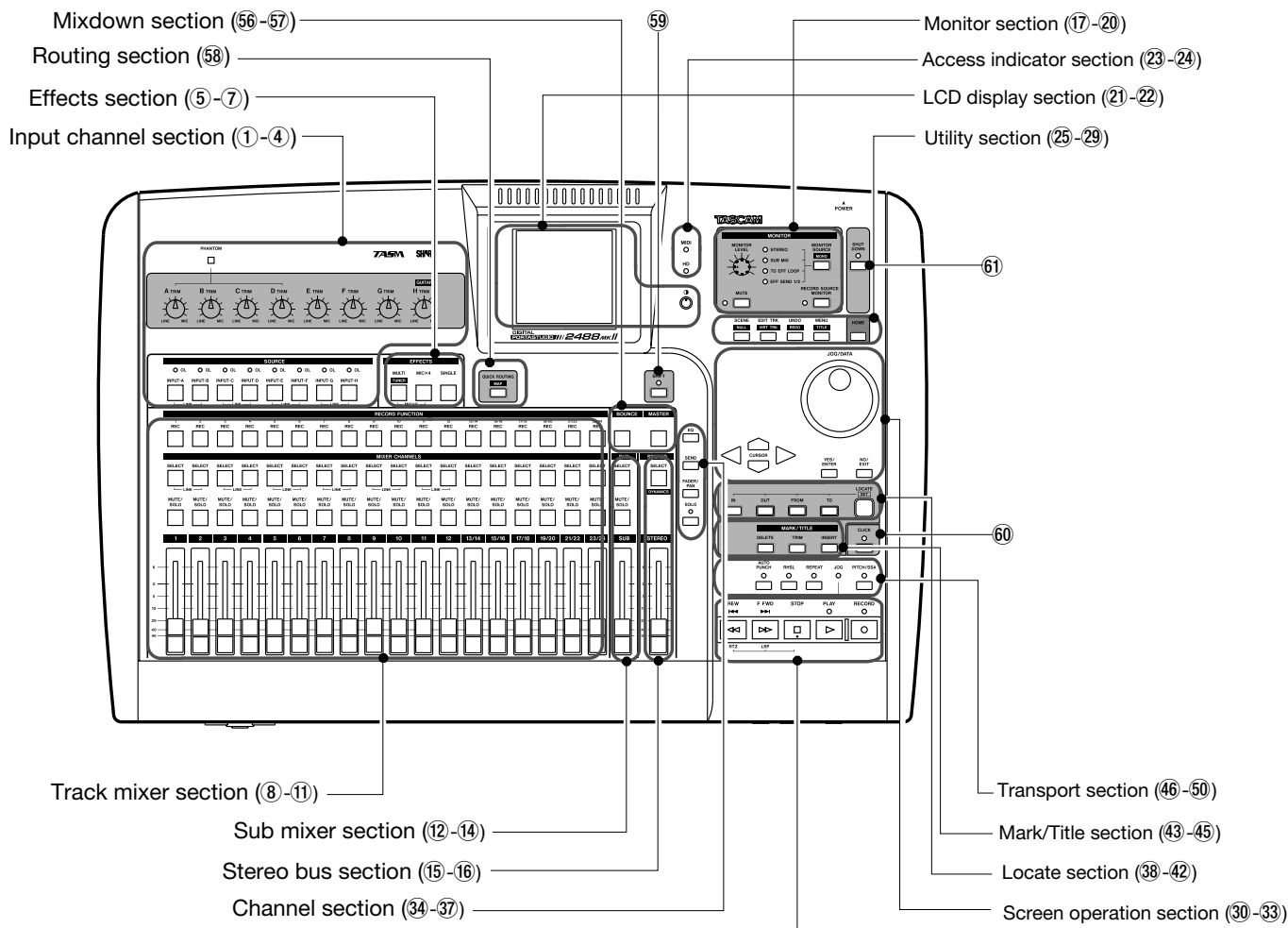

Input channel section

Controls for the 8 input channels (A–H). Input signals can be assigned to the track mixer or sub mixer.

① PHANTOM switch

Turns phantom power for the XLR input jacks on input channels A–D ON and OFF. Turn this switch ON when connecting condenser mics that requires +48 V of external power.

CAUTION

When the PHANTOM switch is ON, do not change the connections for inputs A–D. Do not connect or disconnect mics with the phantom power turned ON.

② TRIM knobs (A–H)

Adjusts gain of MIC/LINE input jacks. Turning clockwise raises gain (increases signal level).

③ INPUT keys (A–H)

Pressing the INPUT key of an input channel selects it as an active channel and the key lights. An active channel is affected by mixer functions and other operations.

These keys are also used for the following purposes.

- To assign an input channel to a track channel or the sub mixer (see “Inputs and assignments” on page 29 and “Sub mixer” on page 35).
- To assign effects to an input (see “Assigning mic effects” on page 39 and “Assigning the multi-effect” on page 41).
- To link inputs next to each other (see “Linking channels” on page 33).

④ OL indicators

These provide warnings about overloaded input levels. If a channel's OL indicator turns red, turn its TRIM knob counterclockwise to reduce the channel's gain.

3 – Names and functions of the 2488MKII

Effects section

These 3 keys access effect functions. See “6–Effects” on page 39 for details.

- ⑤ **MULTI (TUNER) key**
Press this key to open the MULTI EFFECT screen.
To assign the multi-effect to an input or mixer channel, press and hold down this key and then press the **INPUT** or **SELECT** key of the desired channel.
Press this key and the **MICX4** key at the same time to change the active insert effect.
Press this key with the **SHIFT** indicator lit to open the TUNER screen. Press it again to close the TUNER screen.

- ⑥ **MICX4 key**
Press this key to open the MIC EFFECT screen.
To assign a mic effect to an input or mixer channel, press and hold down this key and then press the **INPUT** or **SELECT** key of the desired channel.
Press this key and the **MULTI (TUNER)** key together to change the active insert effect.
- ⑦ **SINGLE key**
Press this key to open the SINGLE EFFECT screen.

Track mixer section

These controls allow up to 24 tracks of audio in the 2488MKII to be mixed. Mixer channel numbers correspond to track numbers. Channels 13 to 24 are stereo track pairs.

- ⑧ **REC keys**
These keys arm and disarm tracks for recording. When ON, they will flash red when record ready and steadily light red when recording.
- ⑨ **SELECT keys**
Pressing the **SELECT** key of a channel selects it as an active channel, and the key lights. An active channel is affected by mixer functions and other operations.
These keys are also used for the following purposes.
- To assign an input channel to a track channel (see “Inputs and assignments” on page 29).
 - To assign effects to a track channel (see “Assigning mic effects” on page 39 and “Assigning the multi-effect” on page 41).
 - To link track channels next to each other (see “Linking channels” on page 33).

- ⑩ **MUTE/SOLO keys**
With the **SOLO** indicator above and to the right of the stereo fader unlit, these keys function as **MUTE** keys, which silence the output of a channel when pressed. (the keys light to show the track’s muted status (see “Mute” on page 33).
When the **SOLO** indicator is lit, these keys function as **SOLO** keys flash to show soloed (see “Soloing and toggle” on page 37).
- ⑪ **Faders**
Each fader adjusts the output level of its track (or track pairs for 13/14 to 23/24).
Depending on the current 2488MKII settings, actual levels and fader positions may not match (see “Fader matching” on page 37).

Sub mixer section

These controls are for the sub mixer.

- ⑫ **SELECT key**
Press this key to open the SUB MIXER screen.
This key is also used to assign inputs **A–H** to the sub mixer, and to assign the sub mixer to the stereo bus.
- ⑬ **MUTE/SOLO key**
This key functions in the same way for the sub mixer as the track channel **MUTE/SOLO** keys do for channels (see “Mute” on page 33).

When the **SOLO** indicator is lit, this key functions as a **SOLO** key and shows that the sub mixer is soloed when flashing (see “Soloing and toggle” on page 37).

- ⑭ **SUB fader**
This fader adjusts the output level of the sub mix bus.

Stereo Bus section

- ⑮ **SELECT (DYNAMICS) key**
Press this key to open the STEREO screen. Use this screen to match internal fader levels with physical fader positions and to make direct output settings (see “Stereo fader” on page 34 and “Direct output” on page 35).
Press this key with the **SHIFT** indicator lit to open the

STEREO DYNAMICS screen (see “Stereo dynamics” on page 34).

- ⑯ **STEREO fader**
This fader adjusts the output level of the stereo bus (and hence the overall level of the mix when mastering).

3 – Names and functions of the 2488MKII

Monitor Section

These controls adjust the output signal sent to the **PHONES** output jack on the front panel and the **MONITOR OUTPUT** jack on the rear panel. See “Monitoring” on page 36 for details.

- ⑰ **MONITOR LEVEL knob**
Adjusts the level of the output signal.
- ⑱ **MONITOR SOURCE (MONO) key/indicator**
Pressing this key cycles through the monitor sources. The indicator lights next to the selected monitor source (**STEREO**, **SUB MIX**, **TO EFF LOOP**, **EFF SEND 1/2**). Pressing this key with the **SHIFT** indicator lit selects

mono monitoring (the monitor source indicator flashes). Press the unshifted **MONITOR SOURCE (MONO)** key again to return to stereo monitoring.

- ⑲ **MUTE key**
This key mutes and unmutes the **MONITOR OUT** signal without affecting the headphone output.
- ⑳ **RECORD SOURCE MONITOR key**
This key selects whether the input source signal is monitored before or after it has passed through the track mixer (see “Record source monitoring” on page 36).

LCD display section

- ㉑ **LCD display**
The display shows various information and setting screens for the operation of the 2488MKII.

- ㉒ **Contrast adjustment knob**
This knob adjusts the display contrast.

Access indicator section

- ㉓ **MIDI indicator**
This indicator lights when MIDI messages are received the **MIDI IN** jack.

- ㉔ **HD indicator**
This indicator lights when data is being read from or written to the internal hard disk.

Utility section

These keys are used to access specific utility screens.

- ㉕ **SCENE (NULL) key**
Opens the **SCENE LIBRARY** screen (see “Scene memories” on page 37).
With the **SHIFT** indicator lit, opens the **FADER NULL** screen (see “Fader matching” on page 37).
- ㉖ **EDIT TRK (VIRT TRK) key**
Opens the **TRACK EDIT** screen (see “About track editing” on page 58).
With the **SHIFT** indicator lit, opens the **VIRTUAL TRACK ASSIGN** screen (see “Virtual tracks” on page 66).
- ㉗ **UNDO (REDO) key**
Opens the **UNDO/REDO** screen. Opens the same

screen with the **SHIFT** indicator lit, but the selected item will be different (see “UNDO and REDO” on page 64).

- ㉘ **MENU (TITLE) key**
Opens the main **MENU** screen (see “Menu screen” on page 14).
Press this key with the **SHIFT** indicator lit to edit the names of scenes, songs, marks, virtual tracks, effect settings and other items.
- ㉙ **HOME key**
Opens the home screen that shows track levels and other information related to recording. Press this key with the **SHIFT** indicator lit to clear the peak meter’s held peak value (when **KEEP** mode is active).

Screen operation section

This section is used to operate the various menus and other screens that appear on the display. The **JOG/DATA** dial is also used for transport jog operation (see “Some general notes on using the 2488MKII” on page 15).

- ⑳ **JOG/DATA dial**
Use the dial to choose items on menu screens and change the values of items on other screens.
When the home screen is open, use the dial to jog the playback position (see “Jog positioning” page 48).

- ㉚ **Cursor keys**
Move the on-screen cursor.
- ㉛ **YES/ENTER key**
Use this key to execute functions, to enter a deeper menu layer, and to answer “YES” to questions.
- ㉜ **NO/EXIT key**
Use this key to prevent execution of a function, to return to the previous menu layer, and to answer “NO” to questions.

3 – Names and functions of the 2488MKII

Channel section

Opens screens for setting mixer channel functions.

- ③④ **EQ key**
Press this key to open the EQ screen of the currently selected channel (input channel, track channel or stereo bus). See “Digital pad/gain” / “EQ” on page 31 and “Stereo EQ” on page 33.
- ③⑤ **SEND key**
Press this key to open the EFFECT SEND screen of the currently selected channel (input channel or track channel). See “Effect send” on page 32.
- ③⑥ **FADER/PAN key**
Press this key to open the FADER/PAN screen of the currently selected channel (input channel or track channel). See “Fader/pan” on page 32.
- ③⑦ **SOLO key/indicator**
Press this key to enter solo mode. When solo mode is ON, the indicator lights, and the **MUTE/SOLO** keys in the row to the left function as **SOLO** keys (see “Soloing and toggle” on page 37).

Locate section

Use these keys to set and locate the edit points. See page 50 for details.

- ③⑧ **LOCATE (SET) key**
Press this key by itself to open the MARK LIST screen that shows mark points.

Press and hold this key and press the **IN**, **OUT**, **FROM**, or **TO** key to set the point represented by that key as the current playback position.
- ③⑨ **IN key**
Press this key while holding down the **LOCATE (SET)** key to set the IN point as the current transport playback position.

Press this key by itself to jump to the IN point.
- ④① **FROM key**
Press this key while holding down the **LOCATE (SET)** key to set the FROM point as the current transport playback position.

Press this key by itself to jump to the FROM point.
- ④② **TO key**
Press this key while holding down the **LOCATE (SET)** key to set the the TO point as current transport playback position.

Press this key by itself to jump to the TO point.
- ④③ **OUT key**
Press this key while holding down the **LOCATE (SET)** key to set OUT point as the current transport playback position.

Press this key by itself to jump to the OUT point.

Mark/Title section

Use these keys to set, erase and adjust marks (up to 999 per song), edit titles and add and remove check marks. See “Mark functions” on page 51 for details.

- ④③ **DELETE key**
Press this key to erase the mark just before the current transport playback position.

Use this key for other functions, including erasing letters during title editing, de-selecting list entries, and erasing entries on the TEMPO MAP and TIME SIGNATURE screens.
- ④④ **TRIM key**
Press this key to open the TRIM screen to edit at the mark position just before the current transport playback position.
- ④⑤ **INSERT key**
Press this key to create a mark at the transport playback position.

Use this key for other functions, including inserting letters during title editing, selecting list entries, and adding entries on the TEMPO MAP and TIME SIGNATURE screens.

3 – Names and functions of the 2488MKII

Transport section

This section has keys for auto punch recording, repeat, pitch control/SSA and other functions, and a jog mode indicator light.

- ④⑥ **AUTO PUNCH key/indicator**
Press this key to turn the auto punch mode ON and OFF (see “Auto punch operations” on page 55).
- ④⑦ **RHSL key/indicator**
Press this key to turn the rehearsal mode ON and OFF. Rehearsal is possible in auto punch mode as well as in normal recording.
- ④⑧ **REPEAT key/indicator**
Press this key to turn the repeat mode ON and OFF.
If you press and hold this button, the REPEAT INTERVAL screen opens where you can set this value (see “Repeat” on page 55).

- ④⑨ **JOG indicator**
Lights when jog mode is active.
- ⑤⑩ **PITCH/SSA key/indicator**
Press this key to turn the varispeed function ON and OFF. The indicator lights when ON.
Hold down the key to open the PITCH/SSA screen, where you can switch between normal pitch control and SSA and make related settings (see “Varispeed operations” on page 68).

Transport keys

In addition to the ordinary operation of individual keys, pushing these keys in combination allows a variety of additional operations (see “Transport controls” on page 47).

- ⑤① **RECORD key/indicator**
Press this key and the **PLAY** key together when the transport is stopped, to start recording. Press this key during playback to start recording at any point.

If the **RHSL** indicator is lit, however, recording will not actually occur.
- ⑤② **PLAY key/indicator**
Press this key when the transport is stopped to start playback. Press this key and the **RECORD** key together when the transport is stopped to drop into recording. Press this key during recording to drop out of recording, but continue playback.

Press this key while holding down the **STOP** key to enter jog mode.
- ⑤③ **STOP key**
Press this key during playback or recording to stop the transport.

Hold down this key and press the **F FWD** key to jump to the last recording start position and stop there.

Hold down this key and press the **REW** key to jump to the beginning of the song.

Hold down this key and press the **PLAY** key to enter jog mode.

Press this key when in jog mode to exit jog mode.

- ⑤④ **F FWD key**
Press this key to skip to the next mark. Press and hold this key to fast forward until you release the key.

Press this key while holding down the **STOP** key to jump to the last recording start position and stop there.
- ⑤⑤ **REW key**
Press this key to skip to the previous mark. Press and hold this key to rewind until you release the key.

Press this key while holding down the **STOP** key to jump to the beginning of the song.

Mixdown section

- ⑤⑥ **BOUNCE key**
Turns bounce mode ON and OFF.
- ⑤⑦ **MASTER key**
Use this key during mastering, to select the pre-mastering mode or master check mode (see “Pre-mastering” on page 69 and “Checking the master” on page 70).

3 – Names and functions of the 2488MKII

Routing section

58 QUICK ROUTING (MAP) key

Use to recall and save routing assignment settings (see “Saving and loading assignments” on page 30).

Press this key with the **SHIFT** indicator lit to open the ROUTING MAP screen where you can see the status of input channel assignments (see “Checking assignments” on page 30).

Other keys

59 SHIFT key/indicator

The shift function is operative when the indicator is lit.

Use the GLOBAL screen of the PREFERENCE menu to select the functionality of the **SHIFT** key (see “Shift key behavior” on page 92).

60 CLICK key/indicator

Turns the metronome click output ON and OFF. When ON, the unit will provide a click according to the METRONOME screen setting (see “Metronome” on page 87).

Press and hold this key to open the FREE METRONOME screen.

61 SHUT DOWN key

Turns the 2488MKII unit off.

If you hold the **SHUT DOWN** key for 2 or 3 seconds, a pop-up screen appears to confirm that you want to shut down.

Always use this key to shut down the unit. This unit has an internal hard disk, and it is necessary to save the song data on the hard disk before turning the power off.

For this reason, always use this key to conduct shut down when you want to turn the unit off (see “Shut down” on page 13).

Front panel

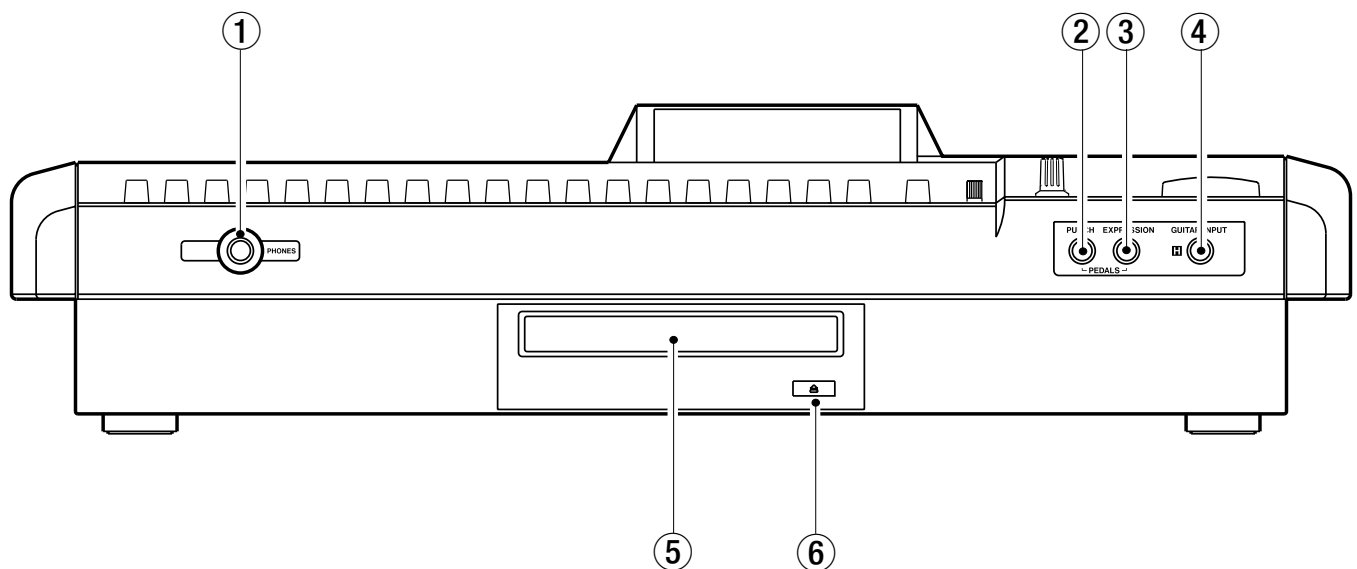

1 PHONES jack

Connect stereo headphones here to listen to the monitor output.

2 PUNCH jack

Connect a TASCAM RC-30P or other foot pedal to control punch in and punch out.

3 EXPRESSION jack

Connect a BOSS EV-5 or other foot volume pedal to control internal effect parameters (see “Editing the multi-effect” on page 41).

4 GUITAR INPUT (H) jack

This is a guitar input jack for input H. Connect a guitar (or bass) with a high impedance pickup.

5 Disc tray

For CD-R and CD-RW discs.

6 Eject button

Use to open and close the disc tray.

Do not press this button when the drive is in operation.

3 – Names and functions of the 2488MKII

Rear panel

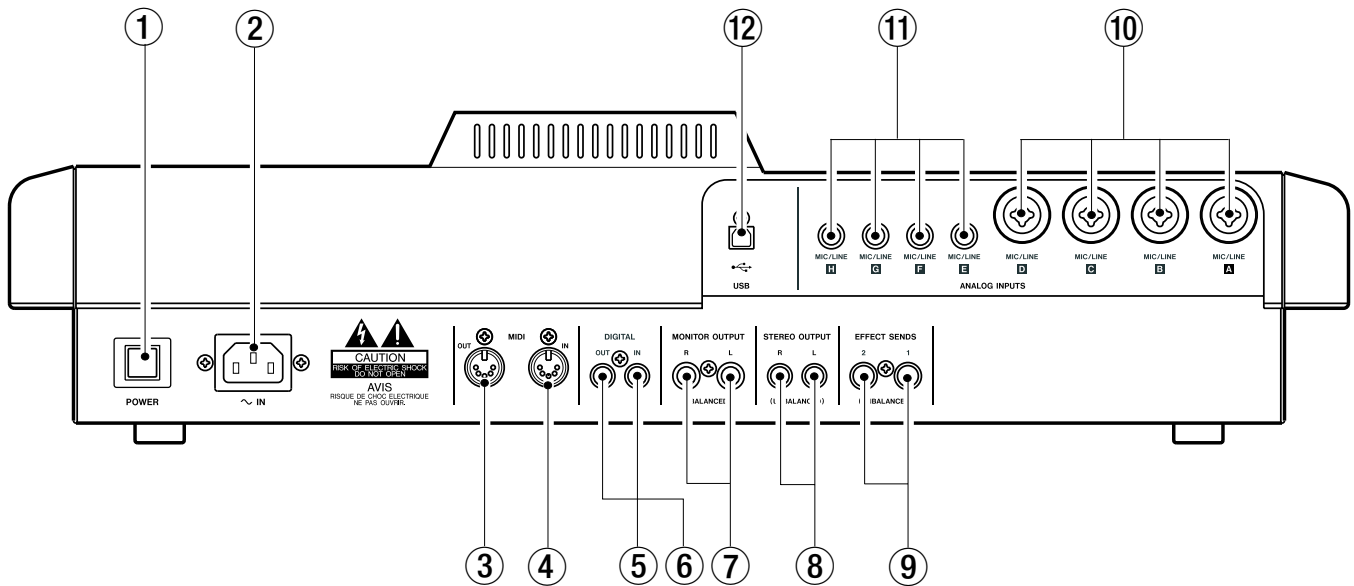

- ① **POWER switch**
Turn the 2488MKII power ON and OFF. Follow shut down procedures before turning power OFF (see “Shut down” on page 13).
- ② **~ IN jack**
Connect the included power cord.
- ③ **MIDI OUT jack**
Sends Program Change and Control Change, MMC commands, realtime messages (such as MTC), common messages and other MIDI messages to connected MIDI devices.
- ④ **MIDI IN jack**
Receives Program Change and Control Change messages, MMC commands and other MIDI commands and messages, from connected MIDI devices.
- ⑤ **DIGITAL IN jack**
Use this jack to receive an S/PDIF digital audio signal, which can then be used as a pair of channel inputs (see “Digital input assignment” on page 29).
- ⑥ **DIGITAL OUT jack**
Outputs the stereo bus signal as an S/PDIF format digital audio signal.
- ⑦ **MONITOR OUT (L, R) jacks**
Outputs the signal selected in the top panel monitor section through these standard balanced 1/4" jacks.
- ⑧ **STEREO OUT (L, R) jacks**
Outputs stereo bus signal.
- ⑨ **EFFECT SENDS (1, 2) jacks**
Output effect sends signals 1 and 2.
- ⑩ **MIC/LINE (A–D) jacks**
Analog input jacks for inputs A–D. These balanced jacks accept both XLR connectors and standard 1/4" plugs.
- ⑪ **MIC/LINE (E–H) jacks**
Analog input jacks for inputs E–H. These balanced jacks accept standard 1/4" plugs.
- ⑫ **USB port**
Use this port to connect the 2488MKII to a computer using USB to exchange files, including audio files and settings, with an attached computer.

4 – Recording

Setting up your first song

This example shows how to record a rhythm guitar, followed by recording an accompanying lead guitar. This is a simple recording, but the same procedures also apply to more complicated recordings, so please read this section carefully.

New song

To make sure we start with a “clean slate,” we will create a new song.

TIP

The 2488MKII is shipped from the factory with a new song ready for you to record. However, if the 2488MKII has been used before, it will automatically load the last song that was worked on, and you may need to follow these instructions to create a new song. Normally, though, this will not be needed.

- 1 Press the MENU key and the MENU screen appears. Use the cursor keys or the JOG/DATA dial to select SONG, and press YES/ENTER.

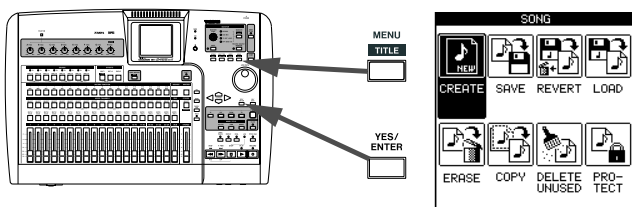
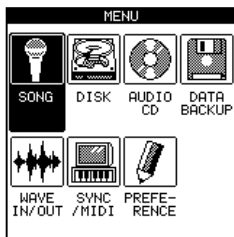

- 2 In the SONG menu, use the cursor keys or the JOG/DATA dial to select CREATE, and press YES/ENTER.

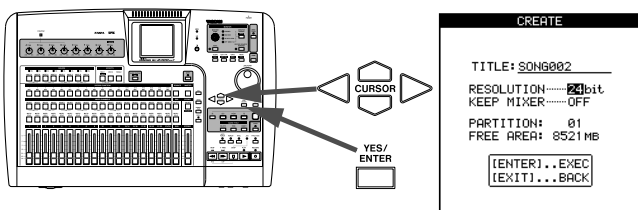

- 3 In the CREATE screen, press the SHIFT key followed by the TITLE key to enter titling mode.

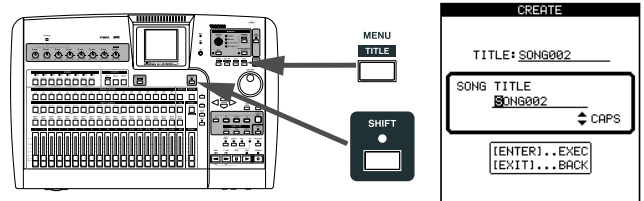

- 4 Use the dial and the cursor keys to give the song a name up to 12 characters in length (see “Titling” on page 15). Press YES/ENTER when you are done. After confirming the song title, the CREATE screen reappears.

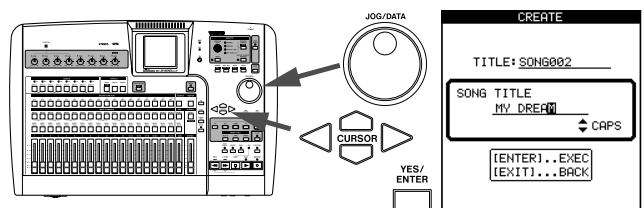

- 5 On the CREATE screen, press YES/ENTER.

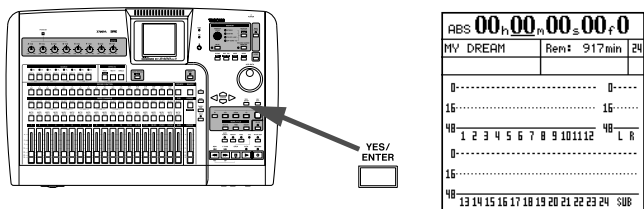

Setting the tempo

The 2488MKII has an internal metronome that can play a click according to the metronome settings or tempo map settings. The initial setting is a simple metronome mode (free metronome mode).

Use the following procedures to set the metronome to 2/4 time with a tempo of ♩ = 100.

- 1 Press and hold the **CLICK** key. The **CLICK** indicator lights orange and the **FREE METRONOME** screen appears.

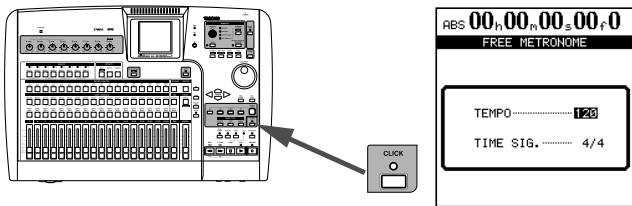

- 2 Use the cursor keys or **JOG/DATA** dial to make the settings below.

TEMPO → 100

TIME SIG. → 2/4

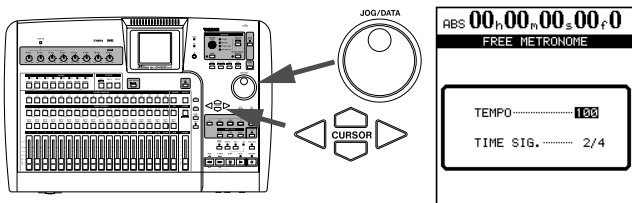

- 3 Press the **HOME** key to return to the home screen.

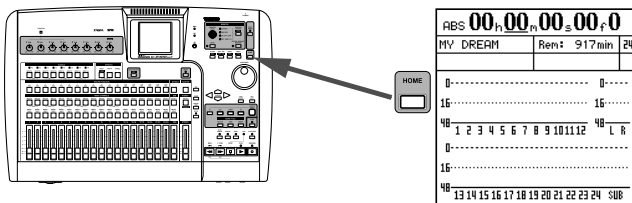

4 – Recording

Making the first recording

We assume that you're recording the rhythm guitar to start with, and that you will be recording it on track 1.

Note that inputs on the 2488MKII are lettered from A through H. Tracks are numbered from 1 through 24.

Input H is special on the 2488MKII—it is duplicated at the front of the 2488MKII with an input for electric guitars and basses (active guitars and basses should use a 1/4" LINE jack at the rear of the unit). Only use this front input jack for passive electric guitars and basses and do not plug these instruments into any other jacks.

Recording the guitar

- 1 Plug the guitar into the GUITAR [H] input on the front of the 2488MKII. Then plug a pair of headphones into the PHONES jack on the front panel.

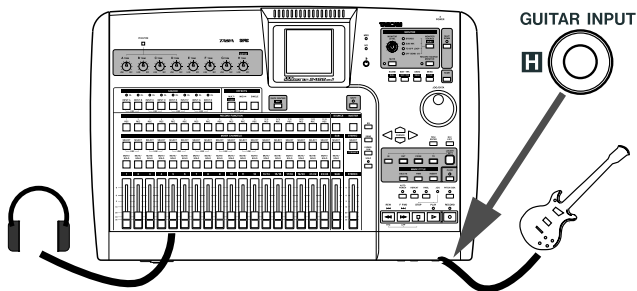

- 2 Play the guitar, and adjust the level using TRIM control H so that when you play a loud note, the OL indicator above the INPUT-H key lights very briefly. Then turn the TRIM counterclockwise a little to set the appropriate level.

If you want to tune the guitar using the 2488MKII, see "Tuner" on page 43.

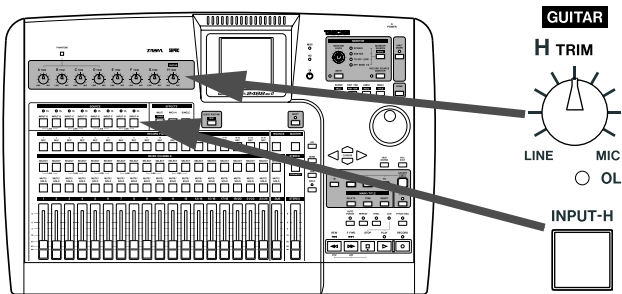

- 3 Press and hold the INPUT-H key so that it starts to flash. While holding it down, press the SELECT key of channel 1. Now both these keys will flash.

Now release both keys. They will both be lit. This means that input H is now assigned to track 1.

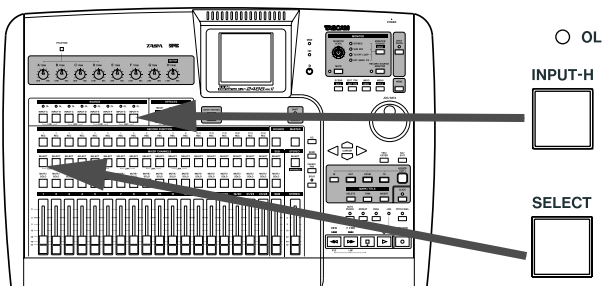

- 4 Press the REC key of track 1. It starts to flash.

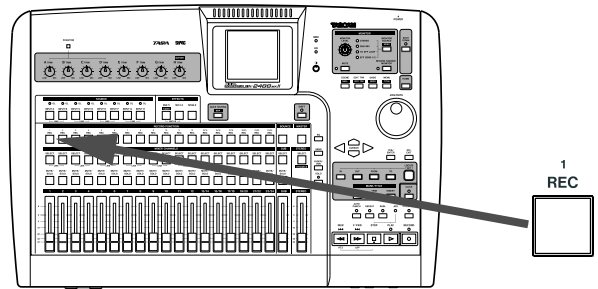

- 5 Set both fader 1 and the STEREO fader to the 0 position.

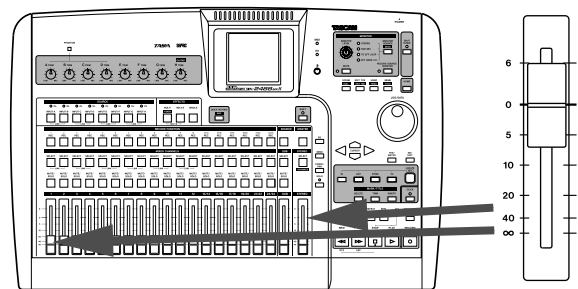

- 6 Confirm that the MONITOR SOURCE is set to STEREO, and use the MONITOR LEVEL knob to adjust the monitor level. You can also monitor in mono (see "Monitoring" on page 36).

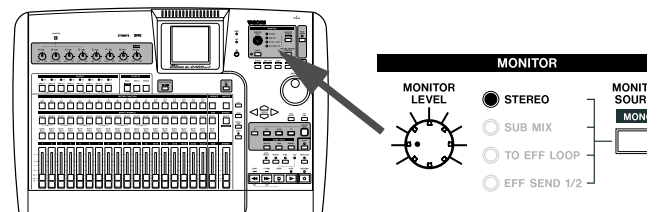

- 7 After pressing the INPUT-H key, press the EQ key and adjust the guitar tone. The sound you hear is the sound that will be recorded.

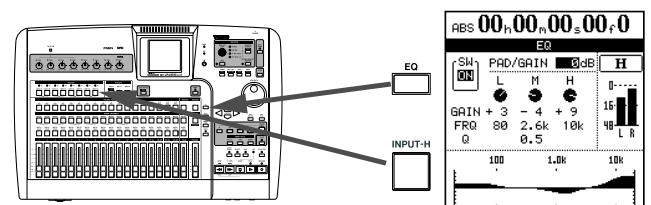

4 – Recording

- 8 Use the cursor keys and the dial to move around the display and change values. The settings are shown as numbers and as a graph.

Use the on-screen SW on the left side of the display (or use SHIFT and YES/ENTER to turn the EQ on, and use SHIFT and NO/EXIT to turn the EQ off) to compare the sound with and without the equalization.

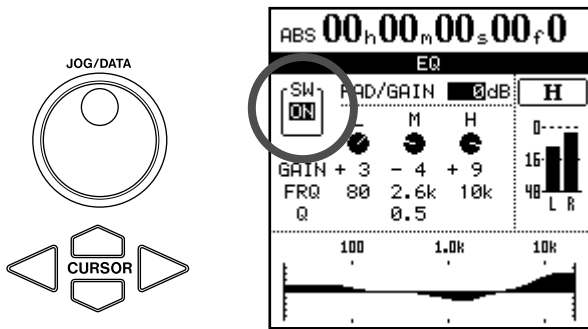

- 9 Press and hold down the RECORD key and press the PLAY key. The PLAY and RECORD indicators above the transport keys both light, and the REC key of track 1 lights solidly.

If you want to rehearse while listening to a metronome click before recording, press the RHSL key to enter rehearsal mode before conducting the above operation. In rehearsal mode, if you press the PLAY key while pressing the RECORD key, a recording rehearsal starts and you can hear the metronome click without actually recording.

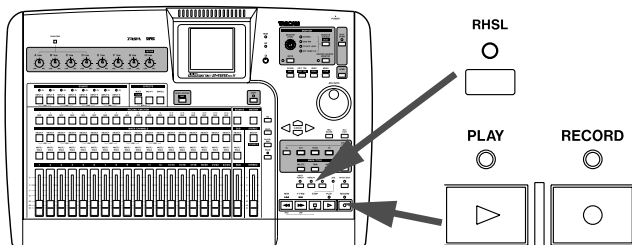

- 10 The metronome you set up earlier starts to play, and you can play your rhythm part along with it, recording as you go. Press the STOP key when you are finished.

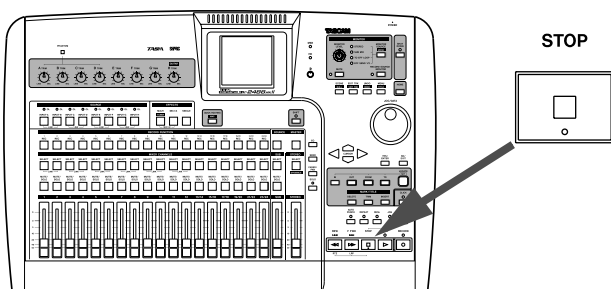

- 11 To return to the zero position, where your song began, press and hold the STOP key, and press the REW key (marked as RTZ—“return to zero”).

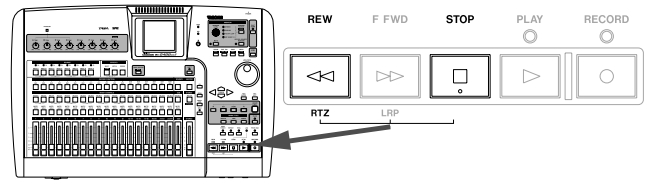

- 12 When you’ve finished recording, press channel 1’s REC key to save the track.

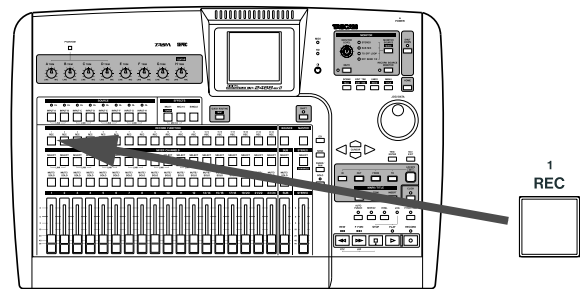

- 13 Press the CLICK key and the indicator goes out.
14 Press the PLAY key and listen to the recorded sound. To re-record press the REC key for track 1 again and repeat from step 9.

4 – Recording

Lead line

Now we can record the lead guitar line. We will add an effect to the lead guitar to make it sound a little more interesting.

TIP

You can also perform audio edits, cutting, copying and pasting between tracks, etc. to correct small mistakes. These operations are explained in "Track editing function" on page 59.

- 1 Press the channel 2 SELECT key while pressing and holding the INPUT-H key to assign guitar input (H) to track 2.

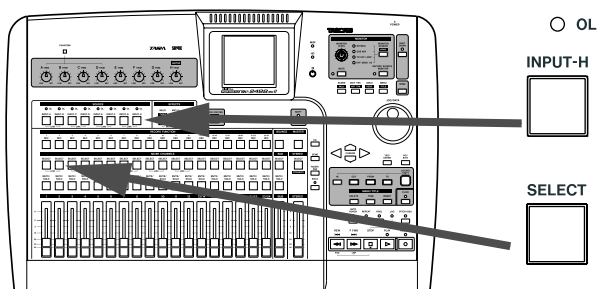

- 2 Press the REC key for track 2 to arm that track for recording. The REC key starts to flash, showing that it is ready to record.
- 3 Set fader 2 to the standard position (0).
- 4 Start song playback, and use fader 1 to adjust the level of the previously recorded track.

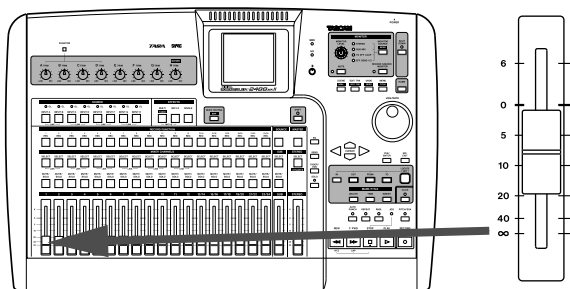

- 5 Press and hold the MULTI key, and press the INPUT-H key to assign the multi-effect to the guitar input (H).

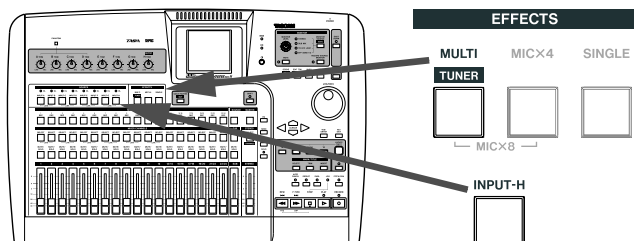

- 6 Press the MULTI key again to bring up the MULTI EFFECT screen.

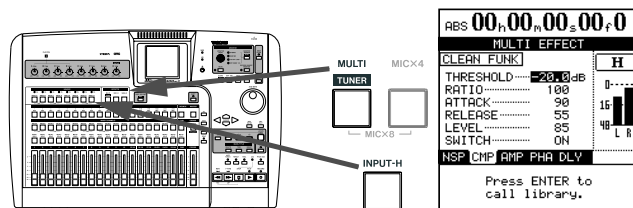

- 7 Press YES/ENTER to show the library choices, move the cursor to PRESET to select the preset multi-effect library.

Use the dial to select the preset multi effect. See "Using the multi-effect library" on page 41 to learn more about using the effects.

Press the YES/ENTER key to load the multi effect.

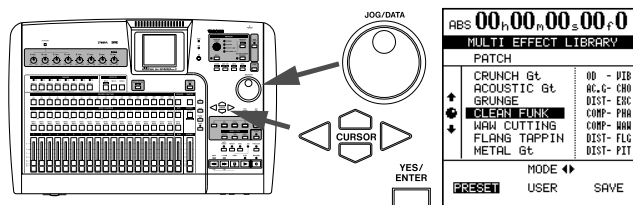

- 8 Press and hold the RECORD key, and then press the PLAY key to start recording track 2.

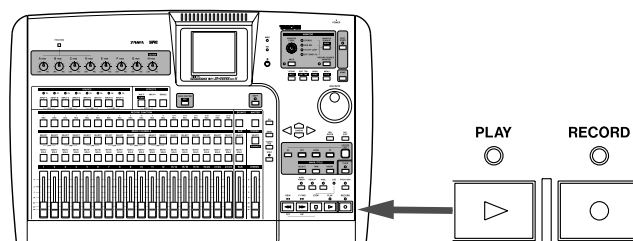

- 9 When finished recording, press the track 2 REC key and the light goes out.

Congratulations!

By now you should be familiar with the basic concepts of the 2488MKII: how the inputs and channels work together; how the mixer controls are accessed and operated, how recording and playback take place, and a little about the location and effect facilities provided by the 2488MKII.

Inputs and assignments

The 2488MKII mixer is equipped with 8 inputs (A–H), 24 playback tracks, and 2 effect returns for a total of 34 channels. 4 of the 8 inputs (A–D) have combined MIC/LINE inputs that can accept both XLR jacks and standard 1/4" TRS jacks. These can also supply +48 V phantom power. Inputs E–H are standard balanced 1/4" jack MIC/LINE inputs.

WARNING

Never connect microphones to inputs A through D, or disconnect microphones from these inputs with phantom power turned on.

Never use unbalanced dynamic microphones with microphone inputs A through D with phantom power turned on. If you are in any doubt, consult your local audio expert.

Always turn this switch OFF when connecting devices that do not need + 48 V external power to the XLR jacks.

An unbalanced “mirror” of H, with an impedance suitable for electric guitars and basses, is provided at the front of the unit.

It is possible to record up to eight tracks at one time, with the inputs being freely assignable to the tracks.

Assigning inputs is carried out by pressing and holding the appropriate input key below the TRIM controls (the key flashes), and then pressing the appropriate channel SELECT key(s) which will also flash. It is also possible to reverse the order (press and hold a channel’s SELECT key and press the appropriate input key).

This shows an instrument (guitar or bass) plugged into input H being assigned to channel 1.

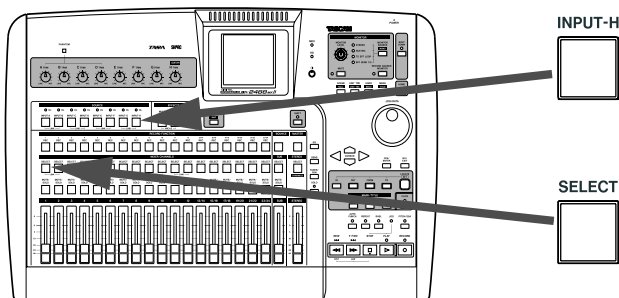

Assignment to a stereo track

Tracks 13–24 form six stereo tracks (13-14, 15-16, 17-18, 19-20, 21-22, 23-24) with each stereo track being controlled by a single fader. Stereo tracks are always recorded as a pair. Recording on only one channel of the pair is impossible.

- When assigning a linked input channel pair to a stereo track each input is assigned to a separate track.
Example: assignment of inputs A and B to tracks 13 and 14
A → 13, B → 14
- When assigning a single input channel to a stereo track, the same input is assigned to both tracks.
Example: assignment of input A to tracks 13 and 14
A → 13, 14
- After a single input channel has been assigned to a stereo track, if a separate input channel is assigned to the same stereo track, the new channel is assigned to the second track of the pair, resulting in each channel being assigned to a separate track.
Example: Input A is assigned to tracks 13 and 14 (A → 13, 14), then, input C is assigned to the same pair of tracks.
A → 13, C → 14

NOTE

By pressing multiple SELECT keys while pressing and holding the INPUT key, a single input can be assigned to multiple tracks.

Multiple inputs cannot be assigned to the same track.

Digital input assignment

The stereo digital signal input through the DIGITAL IN jack on the rear panel can be set as the source for any input channel pair (A–B, C–D, E–F or G–H), replacing an analog MIC/LINE input pair. This setting is made on the MIXER screen of the PREFERENCE menu (see “Digital input channel section” on page 93).

5 – Mixer

Checking assignments

When either an input key (or channel **SELECT** key) is pressed and held down it flashes, together with the channel (or input key) to which it has been assigned. Also, if the **SHIFT** key is pressed, followed by the **MAP** key, a screen is shown with the current assignments.

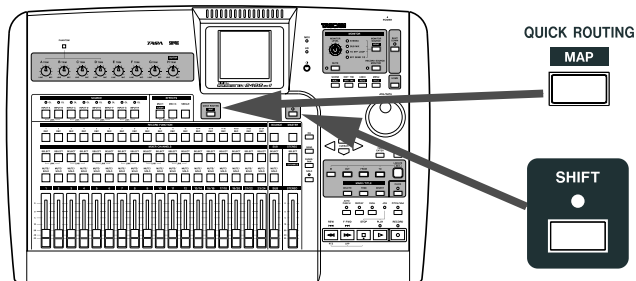

The eight inputs are represented by horizontal lines, which are joined to the channel labels at the bottom of the screen by vertical lines when they are assigned to the channels. Use the **◀/▶** cursor keys to change between viewing channels 1 through 12, and 13 through 24.

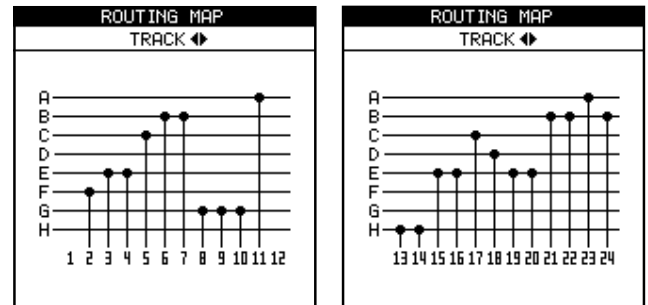

Breaking assignments

If an input or channel **SELECT** key is held down, the assigned **CHANNEL** (or **INPUT**) key flashes. Press the other key to break the assignment.

NOTE

Assigning and unassigning linked channels (see "Linking channels" on page 33) works in much the same

*way as for single channels. Pressing one **SELECT** key of a linked channel pair is typically the same as pressing both together.*

Saving and loading assignments (QUICK ROUTING)

Recording, bounce, and mixdown routing assignment settings can all be saved for easy setup to match your recording system and environment.

- 1 Press the **QUICK ROUTING** key to bring up the screen shown here.

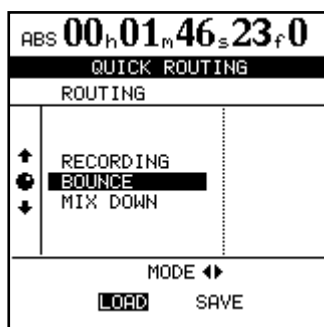

- 2 Use the dial (or **▲/▼** cursor keys) to select the settings to be loaded, or the destination for the current routing assignment settings.
- 3 Use the **◀/▶** cursor keys to select **LOAD** or **SAVE**.
- 4 Press **YES/ENTER**. The routing assignments are either stored or loaded. The home screen briefly shows **Save routing** or **Load routing**.

NOTE

*When bounce routing settings (**BOUNCE**) are loaded, 2488MKII automatically enters bounce mode.*

Channel functions

In this section, we explain the channel functions of the 2488MKII's mixer. The recorder track channels (1–24) and input channels have similar functions, so we explain them

together as channel functions. Stereo bus functions are explained on page 33.

Track channels and input channels

Each of the 24 channels provides the following facilities:

- Digital pad/gain
- 3-band parametric EQ
- Effect sends
- Phase reversal switch
- Pan-pots
- A physical fader (which may be overridden by an internal “virtual fader”)
- A mute key
- Solo facilities

Like the 24 track channels, the eight inputs are provided with phase, digital pad/gain, EQ, effect sends, etc. They are not provided with physical faders, but the output from these “extra channels” can be adjusted on-screen. Although these settings can be made at any time, they are only effective when the inputs have been assigned to the sub mixer. See “Sub mixer” on page 35 for details.

EQ

Press the **EQ** key to display the EQ screen for the current channel. To change the channel, press the **INPUT** key or **SELECT** key of the desired channel.

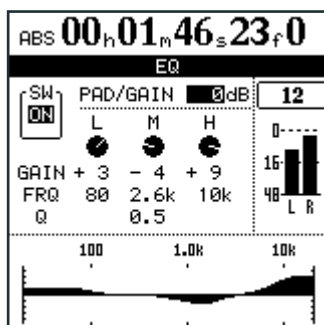

■ Digital pad/gain

Press the channel's **SELECT** key, followed by the **EQ** key (this order can be reversed). Use the cursor keys to navigate to the **PAD/GAIN** area, and set the value to between -42 and +6 dB.

This is usually set at 0 dB, but when boosting EQ, we recommend that you lower the gain to prevent digital clipping.

Use this to add volume to a quiet instrument or to remove excess volume from a loud one. When a channel's EQ screen is shown, simply pressing the **SELECT** key of another channel will show the EQ screen for that channel.

■ EQ

Set the three-band equalization for each channel using the same screen as the digital pad/gain (see above). On the 2488MKII channels, you can adjust the gain (the amount that the signal is cut and boosted) by ± 12 dB, and the frequency (high or low) affected by the equalization in three bands. The frequencies are (in Hz):

- Low (**L**) 32 — 1.6k
- Mid (**M**) 32 — 18k
- High (**H**) 1.7k — 18k

Note that the frequencies are set in discrete steps; it is not possible to set the center frequencies to intermediate values. In addition, you can adjust the “Q” (the width of the effect) in the center band from 0.25 to 16.

TIP

“Q” is defined as the center frequency of the equalization band divided by the bandwidth. A high Q value provides narrow filtering.

As you adjust the equalization, the graph at the bottom of the screen changes to provide an idea of how the equalization affects the signals.

TIP

With the SHIFT indicator lit, press the EQ key to restore all channel EQ parameters to their initial settings.

There is also an on/off soft switch provided at the upper left of the screen to allow A/B comparison of the equalized and unequalized signals. With the SHIFT indicator lit, press **YES/ENTER** to turn it on, and **NO/EXIT** to turn it off (you can also use the cursor).

5 – Mixer

Effect send

There is one stereo “loop” send (using the internal effects) in addition two effect sends (using the external **EFFECT SENDS** jacks) for each channel. Please see “Single effect” on page 42 for details about the use of the internal single effect.

Press the channel’s **SELECT** key, followed by the **SEND** key (this order can be reversed).

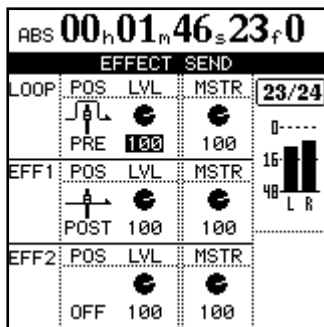

For each effect send, there is a soft switch at the left side of the screen. Use the dial to set this switch either OFF or POST (post-fader) or PRE (pre-fader).

TIP

“Pre-fader” means that the channel fader does not affect the level of the effect send, as opposed to “post-fader” where the effect send level is affected by the channel fader setting.

Set the level of each channel send (**LVL**) from 0 to 127. This screen also allows the master send level (**MSTR**) to be set (again from 0 to 127).

Fader/pan

Press the **FADER/PAN** key to display the FADER/PAN screen for the current channel. To change the channel, press the **INPUT** key or **SELECT** key of the channel to change to.

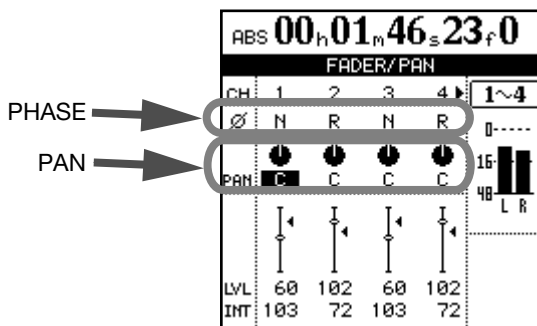

Use this screen to make pan, phase and fader setting for four channels at a time on this screen (linked channels still count as two channels here).

■ Phase

Use this to correct miswired microphones, etc. Out-of-phase sources can result in unnatural EQ and a “hole in the middle” stereo effect. The phase symbol (∅) shows the current status of the channel: either normal (N) or reversed (R). Use the cursor keys and dial to change these settings.

■ Pan

Use PAN parameters to set the stereo position.

In the track channels, this parameter sets the pan positions of the signals sent to the stereo bus. In the input channels, it sets the pan positions of signals sent to the sub mix bus.

Full left (“hard left”) is represented by L63, and hard right by R63. The center position, where the signal is sent equally to the left and right is represented by C.

TIP

With the SHIFT indicator lit, press the PAN key to reset the highlighted channel’s pan position to the center. In the case of linked channels, the pan position both of the highlighted channel and the channel to which it is linked will be centered.

■ Faders

The on-screen track channel faders are for display only.

The input channel faders adjust the levels of the signals sent to the sub mix bus. Select then with the cursor and use the **JOG/DATA** dial to set them.

The minimum fader value as shown on screen is 0 (full cut), and the full level is 127. A level of 100 corresponds to the “unity gain” position of 0 dB.

In the initial preference settings, the positions of the physical faders on the top panel and the actual fader levels (internal fader values) always correspond, but different fader matching settings may cause the positions and actual values to differ.

In this case, the ◀ next to the fader icon on screen shows the internal fader position (when the internal fader and physical fader values are equal, no ◀ appears).

See “Scene recall” on page 37 and “Fader matching” on page 37 for details.

Mute

The **MUTE** keys for each channel also serve as solo keys (see “Soloing and toggle” on page 37).

When a channel’s **MUTE** key is pressed (when soloing is not active), the orange indicator lights, and the sound from that channel is not sent to the stereo bus. The channel’s recording source is also muted.

Linking channels

Adjacent track channels and input channels can be linked. By linking channels, the parameters of 2 channels (usually the left and right channels of a stereo pair) can be controlled simultaneously.

A linked pair can be formed with an odd-numbered channel and the even-numbered channel immediately to its right. For example, channel 1 can be linked with channel 2, and channel 5 can be linked with channel 6.

To create a link, press and hold the **SELECT** key (or the **INPUT** key) of one of the channels that you want to link and then press the **SELECT** key (or the **INPUT** key) of the other channel.

To cancel the link, follow the same procedures. Press and hold the **SELECT** key (or the **INPUT** key) of one of the channels and then press the **SELECT** key (or the **INPUT** key) of the other channel.

When track channels are linked, the following parameters can be controlled simultaneously:

- Faders (the left fader of the linked pair controls the levels for both channels)
- EQ
- Digital pad/gain
- Effect send levels and pre/post selection

When input channels are linked, the following parameters can be controlled simultaneously.

- Internal fader values
- EQ
- Digital pad/gain
- Effect send levels and pre/post selection

Stereo bus functions

The stereo bus may be thought of as a special permanently-linked pair of channels. The output from this bus can be monitored as the **STEREO** selection (see “Monitoring” on page 36) and is also as the source for mastering and rendering the final mix (see “Mastering and CD recorder” on page 69).

At the final mastering stage, it is possible to add equalization and dynamics to the stereo bus.

Stereo EQ

Like the ordinary channels, the stereo bus has three-band equalization, with sweepable center frequencies, and variable Q for the midrange.

To access this;

- 1 Press the **SELECT** key.

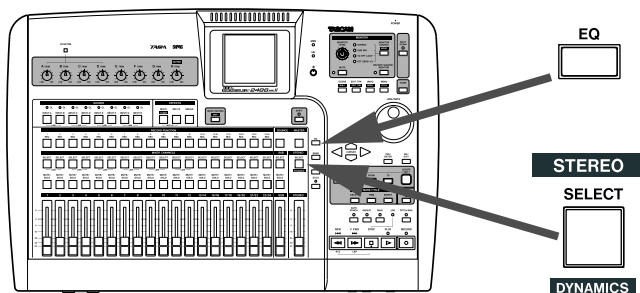

- 2 Press the **EQ** key:

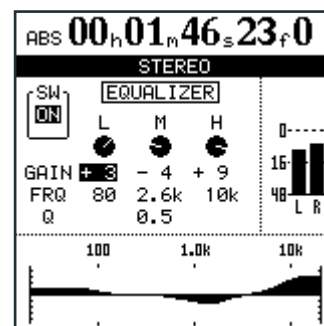

- 3 Use the cursor keys and dial to select and adjust the EQ parameters for the stereo bus. See “EQ” on page 31 for information about setting methods, etc.

5 – Mixer

Stereo dynamics

The stereo bus has a stereo dynamics processor (compressor or expander) available.

- 1 With the **SHIFT** indicator lit, press the **SELECT** key. The **STEREO DYNAMICS** screen appears.

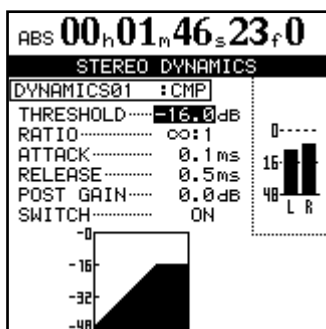
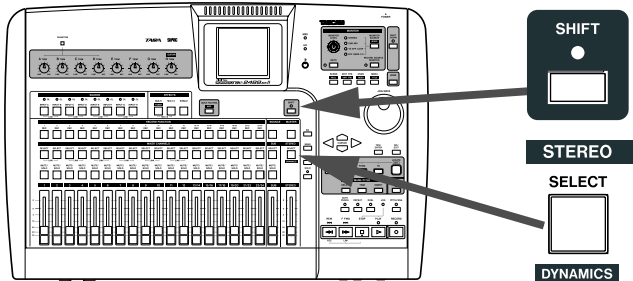

- 2 Press the **YES/ENTER** key. The **DYNAMICS LIBRARY** screen appears.

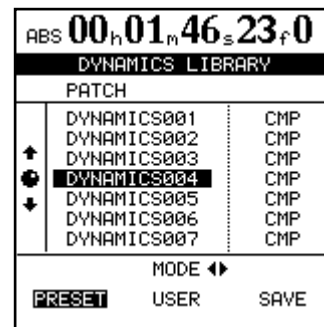

- 3 Use the **◀/▶** cursor keys to select preset setting (**PRESET**) or the user setting (**USER**).

The **PRESET** category contains factory preset settings, while **USER** can be used to save and recall custom settings.

- 4 Use the dial to select library entries
- 5 Press **YES/ENTER** to load the entry.

The **STEREO DYNAMICS** screen reappears, and the selected preset parameters appear.

- 6 Use the cursor keys and dial to select and adjust the parameters for the effect. Note that the last parameter is an on/off switch. When set to off, the dynamics processor is bypassed.

Stereo fader

Press the **STEREO** key to open the screen below.

As with the channel fader screen, the on-screen fader cannot be used to make adjustments. Also note that the internal fader value and the top panel physical fader position may not correspond (see “Faders” on page 32).

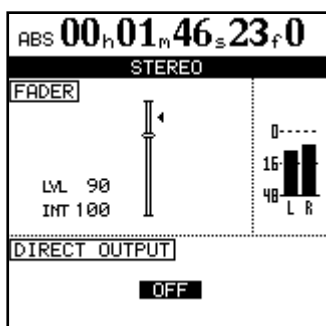

In this case, the **LVL** value corresponds to the physical fader level, and **INT** gives the internal virtual fader value (as marked by the triangular symbol beside the on-screen fader).

In both cases, 0 is full cut, 127 is full up, and 100 is the unity gain value.

Direct output

A pair of tracks can be routed for direct output through the analog **STEREO OUT** jacks (and the **DIGITAL OUT**).

While the above screen is shown, if you use the **JOG/DATA** dial to select linked or paired tracks (1/2–23/24), the track signal bypasses the mixer and stereo faders and is output directly from the **STEREO OUT** jacks. Usually this function is OFF.

NOTE

The direct output signal is a track playback signal that does not pass through the mixer channel. EQ, insert effects, the channel fader and the stereo fader all become ineffective.

Sub mixer

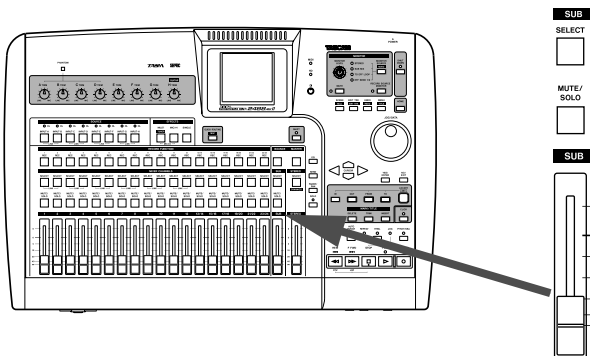

The 2488MKII sub mixer facility allows you to add up to eight more inputs (usually on mixdown) to the twenty-four tracks already recorded. These could be inputs from a multi-timbral MIDI device, synchronized using MIDI clock information from the 2488MKII driving a sequencer. The eight inputs from **A** through **H** are pressed into service here and they feed a bus that can be routed to the stereo bus (or to the recorder in bounce mix—see “Making a bounce mix” on page 58).

- 1 To assign an input to the sub mixer, while pressing and holding its **INPUT** key, press the sub mixer channel’s **SELECT** key.
- 2 Repeat this process for all inputs to be assigned to the sub mixer.
- 3 While pressing and holding the sub mixer section **SELECT** key, press the **STEREO** section’s **SELECT** key.

Finally, assign the sub mixer itself to the stereo bus. To see the sub mixer status, press the sub mixer section **SELECT** key to show the **SUB MIXER** screen:

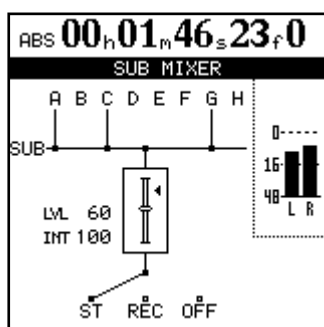

This shows the current assignment of inputs to the sub mixer, and the current assignment of the sub mixer output.

You can also adjust the level of the sub mix bus output using the **SUB** fader in sub mixer section.

NOTE

The 2488MKII has a track bounce function. This function allows you to choose and mix multiple previously recorded track signals and record them to another track (see “Bouncing tracks” on page 58).

When you use this function, the bounce source track signal is sent to the sub mix bus, and this sub mix bus signal is then sent to the bounce destination track.

*When using this, the sub mix bus assignment destination is set to **REC** in the **SUB MIXER** screen shown above.*

5 – Mixer

Monitoring

Monitoring is a vital part of the whole recording and mastering process. The 2488MKII provides stereo monitoring facilities through an external amplifier/speakers combination, as well as headphones. The level for these two monitoring systems is set using the **MONITOR LEVEL** control. This monitoring level is affected by the level from the **STEREO** fader, but does not affect the level of the stereo bus.

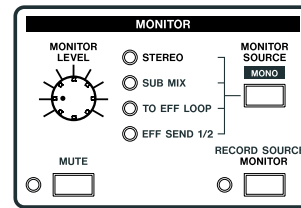

Monitor selection

As well as the stereo bus, it is possible to monitor the sub mixer (see “Sub mixer” on page 35), the effect loop, and the two effect sends (one in each channel), which are all shown by indicators; as well as turning off the monitoring, when no indicator is lit.

Monitoring the loop and effect sends is useful when you want to check the exact mix (as created by the effect sends) of the signals being sent to the effects. Use the **MONITOR SELECT** key to cycle through the selections.

Mono monitoring

Typically monitoring is carried out in stereo, echoing the stereo bus. However, there may be times when you want to check what the mix sounds like in mono.

While the monitoring is in mono, the appropriate monitor selection indicator flashes. Use the **MONITOR SOURCE** key to turn off mono monitoring.

When you want to monitor in mono, press the **MONITOR SOURCE (MONO)** key while the **SHIFT** indicator is lit.

Record source monitoring

Using the 2488MKII, you can apply input channel EQ and insert effects as you record the input channel signal (recording source). The sound that you hear on your headphones or monitoring speakers, though, will ordinarily also have track mixer EQ and insert effects applied. This allows you to listen to the signal as it will sound during future playback (that is, with track mixer EQ and insert effects applied) while you are recording.

Moreover, to make it easy to monitor the recording source, you can always use the track mixer pan-pots and faders to change the stereo position and volume as needed (this will not affect the recorded signal).

NOTE

Even when the recording source monitoring function is ON, track mixer EQ and insert effects are applied to the playback signals of already recorded tracks.

However, there may be times when you want to hear the signal that you are actually recording to the hard disk (the recording source).

To use this function, just press the **RECORDING SOURCE MONITOR** key. The indicator lights when recording source monitoring is in operation.

If you turn the recording source monitor function ON, track mixer EQ and insert effects are not applied to the recording source during recording. This allows you to listen to the sound of just the input channel EQ and insert effects.

Monitor muting

Mute the monitor output by pressing the monitor section **MUTE** key so that indicator lights. The headphone output is not muted. This function is convenient when you want to silence the monitor speaker output temporarily because, for example, you want to listen with headphones for a moment or the phone rings.

Soloing and toggle

If you press the **SOLO** key to the upper right of the **STEREO** fader, the indicator lights and solo mode activates. In solo mode, the track channel **MUTE/SOLO** keys function as **SOLO** keys, allowing you to monitor just the track channel signals of your choice.

The **MUTE/SOLO** keys of any soloed channels flash while being soloed.

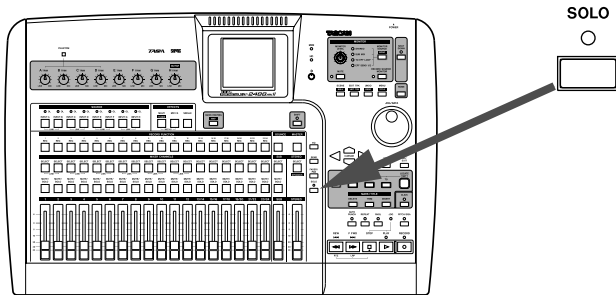

Muted channels cannot be soloed or unmuted while solo mode is active.

When soloing channels, the solo is “in-place,” meaning that faders, pan controls, EQ, etc. affect the soloed sound, and channels other than those with their **SOLO** keys pressed are muted.

Scene memories

The 2488MKII can store and recall up to 100 scene memories. Each memory stores all the digital parameters for:

- Input assignment
- EQ settings
- Effect settings and assignment (assignment and parameters for both internal effects units)
- Effect send and loop levels
- Pan-pots

- Digital pad/gain
- Fader settings (including the **STEREO** fader)
- Sub-mixer settings

NOTE

Monitor settings and TRIM control settings are not stored as part of a scene.

Scene recall

Follow these procedures to recall a scene.

- 1 Press the **SCENE** key to open the **SCENE LIBRARY** screen.

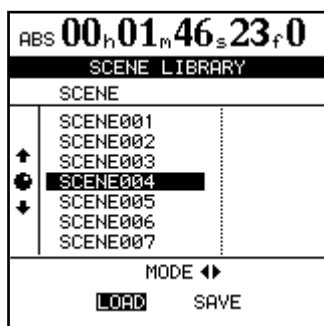

- 2 Use the **◀** cursor key to select **LOAD**.
- 3 Select the scene that you want to recall.
- 4 Press the **YES/ENTER** key to recall the scene.

■ Internal faders and physical faders

If the fader matching mode (described below) is changed from the factory setting, when a scene is recalled, the

recalled internal fader values and the physical fader positions may not match.* For this reason, audio levels may change suddenly after recalling a scene. Remember to turn down the output volume when recalling scenes to avoid sudden changes in volume.

*In the factory fader matching setting, the internal fader values always match physical fader positions.

NOTE

If the fader matching setting is changed from the factory setting, the following cases may also cause the internal fader values and physical fader values not to match:

- If a different song is recalled.
- If external MIDI fader control is used.
- If a physical fader position is changed while the unit's power is OFF.

■ Fader matching

If the fader matching mode is not changed from its factory settings, then the physical fader positions will always show the actual fader levels (internal fader values) when you use the 2488MKII. In this setting, however, fader data is not recalled with scenes.

5 – Mixer

If the fader matching setting is changed from the factory setting REAL, to JUMP or CATCH as described below, then fader data will be recalled together with scenes. Immediately after recall, though, the physical fader positions may not match the internal fader values and the initial effect of a moving a physical fader then depends on the fader matching mode.

Change the fader matching setting with the FADER MATCHING item on the MIXER screen of the PREFERENCE menu. Choose one of the following three options (see “Mixer preferences” on page 92).

REAL mode (factory setting):

The internal faders are always controlled by the physical faders.

In other words, the internal faders and physical faders are always matched. Scene recall does not recall fader values, and MIDI cannot be used to control faders.

JUMP mode:

The moment a physical fader is moved, it takes control of the level, sending its value to the internal fader.

CATCH mode:

The moment a physical fader reaches the value equal to the current internal fader value, it takes control of the level.

■ Matching the physical faders with internal fader values

Use the FADER NULL screen to match physical fader positions with recalled internal fader values.

With the SHIFT indicator lit, press the SCENE (NULL) key to open the FADER NULL screen.

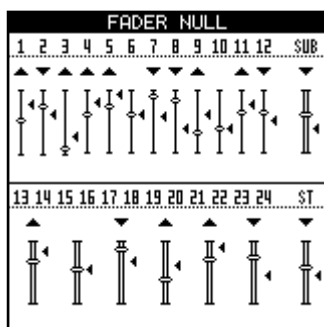

This screen shows the current physical fader positions. The ◀ symbols next to the fader icons show internal fader positions.

When a physical fader position and internal fader position are not matched, a ▼ or ▲ will appear above the fader icon. These triangles indicate whether a physical fader needs to be (raised ▲ or lowered ▼) to match its internal fader position.

When a physical fader position and its internal fader position are matched, no symbol appears above the fader icon.

NOTE

The FADER NULL screen is only for matching physical faders with internal fader positions. While this screen is open, moving the physical faders will not change the actual fader levels (internal fader values and the fader matching mode has no effect).

Saving scenes

Save your current settings (scene) to the library using the following procedures.

- 1 Press the SCENE key to open the scene library screen.
- 2 Use the ► cursor key to select SAVE.
- 3 Use the JOG/DATA dial to select the destination for saving. If you choose a destination that already contains scene data, you will overwrite it. To create new scene data, select “New Scene.”
- 4 If you selected “New Scene,” press the SHIFT key and press the MENU (TITLE) key to open the title input pop-up screen where you can input the scene name (see “Titling” on page 15).
- 5 Press the YES/ENTER key to save the current scene.

This chapter explains the built-in insert effects that can be applied to individual mic and guitar inputs and the mixdown/mastering effects (single effect).

In addition to insert effects and single effects, this unit also has a built-in dynamics processor for the stereo bus. Please see “Stereo dynamics” on page 34 for more information.

Depending on the mode, insert effects can be used as either four mic effects and one multi-effect (guitar effect) or as eight mic effects.

Single effects can be used for internal effect loops (see “Effect send” on page 32).

The parameters of the effects may be edited and stored in libraries allowing the same effect setting to be used on multiple tracks or used in different parts of the same project.

These library effects are also available for use in other songs even on difference disk partitions.

Whether or not the parameters are stored in a library entry, effect assignments and parameters are always stored as part of a song.

NOTE

The 2488MKII and the original 2488 use different library data formats that are not compatible. You cannot transfer effect setting between the two different types of unit.

Settings insert effect modes

There are 2 insert effect modes.

MIC X4 mode 4 mic effects and the multi-effect can be used in this mode.

MIC X8 mode 8 mic effects can be used in this mode.

TIP

You can check which mode you are in at any time by pressing the MULTI key or MICX4 key. If only the key that you press flashes, the current mode is MIC X4 mode. If both the MULTI and MICX4 keys flash, then the current mode is MIC X8 mode.

To change the current mode, press the **MULTI** and **MICX4** keys simultaneously.

After selecting the insert effect mode, assign it to an input or track channel (see “Assigning mic effects” on page 39 and “Assigning the multi-effect” on page 41).

CAUTION

When you change from MIC X4 mode to MIC X8 mode, the multi-effect assignment is cancelled, but the mic effect assignments are kept.

When you change from MIC X8 mode to MIC X4 mode, all the mic effect assignments are cancelled.

Mic effects

MIC X 4 Select four mic effects and the multi-effect by pressing the **MICX4 EFFECT** key. If the eight mic effects setting has previously been selected, the mic effect assignments already made are unassigned.

MIC X 8 Select eight mic effects by using the **MULTI** and **MICX4** keys (**MICX8**) located above the channels. Press and hold one of these keys and then press the other one.

If the four mic effects + multi-effect setting is already selected, the multi-effect is unassigned, and the four mic effect assignments are left in place.

To “unlink” these two keys, press and hold them together again.

Assigning mic effects

Assigning input channels and track channels is similar to the way that channels are assigned to inputs.

In other words, pressing and holding the **MICX4** key (whether four or eight mic effects are selected) and pressing a channel **INPUT** or **SELECT** key assigns the mic effect to that channel.

Unassigning works the same way.

If all available mic effects are being used, attempting to assign one to another input channel or track channel has no effect. You must free up (unassign) effects on some inputs or channels to allow new ones to be assigned.

A stereo track channel pair (13-14 through 23-24) counts as two channels. In other words, in **MICX8** mode, mic effects can be assigned to up to four stereo channels (equivalent to eight mono channels).

6 – Effects

Selecting mic effects

- 1 When the MICX4 key is pressed (regardless of whether eight or four mic effects have been selected), and the SELECT key of the input or track is pressed, the MIC EFFECT screen is shown:

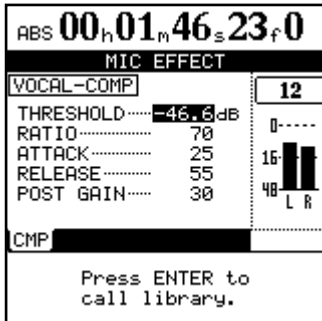

- 2 Press the SELECT or INPUT key for the track or input channel to assign the mic effect to it. The MIC EFFECT screen for that channel appears.
 - 3 Press the YES/ENTER key.
- MIC EFFECT LIBRARY screen appears.

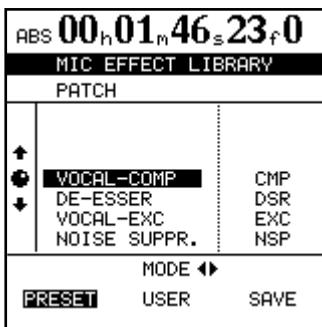

- 4 Use the left and right keys to select either the preset (PRESET) library, the user library (USER) or save (SAVE) the current setting.

The basic types of mic effects available are:

- Vocal compressor (CMP)
- De-esser (DSR)
- Vocal exciter (EXC)
- Noise suppressor (NSP)

- 5 Use the dial to select the effect to load (or when saving, the “slot” in which to save).
- 6 Press YES/ENTER to load (or save) the effect. The selected settings are recalled as mic effect settings for the current channel, and the MIC EFFECT screen shows the parameters.

Pressing NO/EXIT cancels the load and returns the settings to the previous parameters.

Editing mic effects

The parameters to be edited for the effects differ according to the type of effect selected. See “Appendix” on page 98 for details about editing the parameters of different types of effects.

TIP

If you are unsure of the operation of a compressor or any of the effects described here, it is a good idea to read one of the many excellent introductory books on audio and recording.

NOTE

Even if no mic effects are assigned, you can still edit the parameters on each channel. You must assign the mic effects in order to use them.

Multi-effect

On the 2488MKII, a “multi-effect” is a chain of effects which can be used together as one insert effect for processing a guitar sound, for example. A multi-effect is made available together with the four mic effect setting.

Selecting the multi-effect for use is done in the same way as selecting the four mic effects (see “Editing mic effects” page 40).

Assigning the multi-effect

The multi-effect is assigned in the same way as the mic effects: press and hold the **MULTI** key and press the input or channel **SELECT** key. Any input or channel assigned when the **MULTI** key is first pressed flashes.

Unassigning the multi-effect follows the same procedure: press and hold the **MULTI** key, and press the flashing **SELECT** key.

NOTE

The multi-effect can be freely assigned to mono inputs or channels or to linked or stereo input or channels.

Editing the multi-effect

You can edit the parameters of the selected multi-effect. The editable parameters depend on the effect type.

Press the **MULTI** key to open the MULTI EFFECT screen where you can edit the parameters.

At the bottom of the screen, each of the effects in the multi-effect is shown with an abbreviation. These effects are connected in a chain in the order displayed. This order cannot be changed.

Use the ◀/▶ cursor keys to select the effect you want to edit. The editable effect parameters are shown in the upper part of the screen.

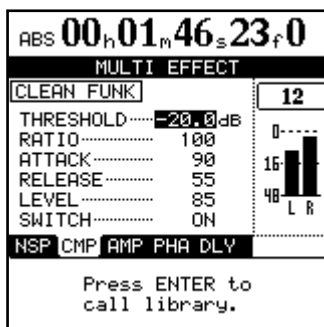

NOTE

You can use an external expression pedal to control a single (non-selectable) parameter for each of the 4th stage effects (flanger, phaser, chorus, exciter, pitch, tremolo, vibrato, wah). Set PEDAL to ON to make pedal control possible.

Using the multi-effect library

- From the MULTI EFFECT parameter screen, press YES/ENTER:



- Use the JOG/DATA dial (or ▼/▲ cursor keys) to select the multi-effect setting that you want to use from the list.
- Press the YES/ENTER.

The setting that you select becomes the multi-effect for the current input/channel and its parameters appear on the MULTI EFFECT screen.

Pressing the NO/EXIT key returns to the MULTI EFFECT screen without saving.

- Use the ◀/▶ cursor keys to select either the **PRESET** memory banks, the **USER** memory banks, or **SAVE** the current setting. The left side of the **PRESET** memory banks provides a description of the effect (**GRUNGE**, **CLEAN FUNK**, etc.).

The library list shows the preset names (left) and the two main effects used (right).

6 – Effects

Saving multi-effect settings

You can save an edited setting as a user setting in the library.

- 1 When the **MULTI EFFECT** screen is visible, press the **YES/ENTER** key to open the **MULTI EFFECT LIBRARY** screen.
- 2 Use the **◀/▶** cursor keys to select **SAVE**.
- 3 Use the **JOG/DATA** dial (or the **▲/▼** cursor keys) to select a setting slot to store the new setting.
- 4 Rename the setting if you want (see “Titling” on page 15).

NOTE

The right column of the list shows the basic effect types (**DIST-FLG**, etc.) used in each setting so they will always be clear regardless of the setting names.

- 5 Press the **YES/ENTER** key to save the setting and return to the **MULTI EFFECT** screen.

NOTE

This overwrites any existing setting in that slot.

Press the **NO/EXIT** key to return to the **MULTI EFFECT** screen without saving.

Single effect

The single effect provides you with a quality effect in the internal effect loop. This is most useful in the mixdown and mastering stages, but it can be used at any time.

Input channel and track channel signals can be sent to the single effect. Channel signal send levels and pre/post selection are set on the **EFFECT SEND** screen (see “Effect send” on page 32).

The return from this effect is sent to the stereo bus, or to the bounce sub mix (“Making a bounce mix” on page 58).

Press the **SINGLE EFFECT** key. It lights, and the screen changes to the **SINGLE EFFECT** screen:

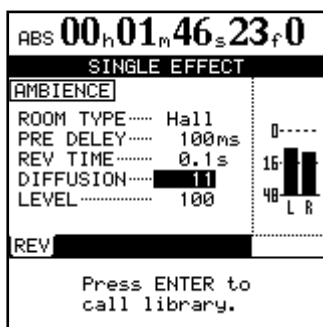

Press the **YES/ENTER** key to enter the library screen to recall a preset effect or a user effect or to save the current parameters.

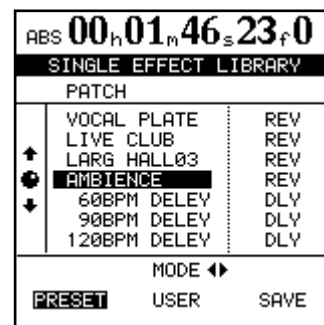

Use the **◀/▶** cursor keys to select the **PRESET** choices, the **USER** settings, or to **SAVE** the current parameters.

Scroll up and down through the list that appears, and press **YES/ENTER** to confirm your choice.

Saving single effects

As with mic effects and multi-effects, single effect settings can be saved as user settings in the library.

- 1 With the **SINGLE EFFECT** screen open, press the **YES/ENTER** key to open the **SINGLE EFFECT LIBRARY** screen.
- 2 Use the **◀/▶** cursor keys and select **SAVE**.
- 3 Use the **JOG/DATA** dial or the **▲/▼** cursor keys to select a slot for saving the settings.

- 4 Add a name if you like (see “Titling” on page 15).
- 5 Press the **YES/ENTER** key to save the setting and return to the **SINGLE EFFECT** screen.

If you press the **NO/EXIT** key, you will return to the **SINGLE EFFECT** screen without saving.

Tuner

This is not really an effect, but uses one of the effect keys.
Press the shifted **MULTI** key to bring up the TUNER screen.

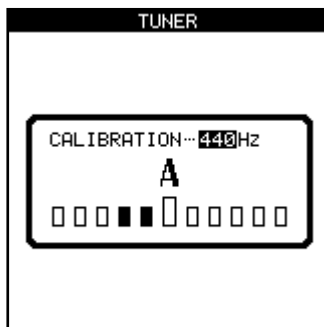

The tuner is used with the signal from input **H** (reserved for guitars and basses). It cannot be used with any other input. When a note is played, the 2488MKII tuner displays the note closest to that note, and the bars under the name show whether the actual note is more sharp (the bars to the right of the center are highlighted) or flat (the bars to the left of the center are highlighted) than the true value. When the larger center bar alone is highlighted, the instrument is tuned to the displayed note.

You can set the reference **A** to a value other than 440 Hz if necessary.

Exit the tuner by pressing the shifted **MULTI** key again.

7 – Recorder

First steps in recording (song management)

These functions are not completely recorder-related, but they do have play important roles in the recorder operation. These are all accessed through the SONG menu from the main menu.

Press **MENU**, navigate to **SONG**, and press **YES/ENTER**.

Creating a song

Before starting a new recording, you must follow these procedures to create a song.

- 1 Press the **MENU** key to open the **MENU** screen. Use the cursor keys to choose the **SONG** item, and then press the **YES/ENTER** key.
- 2 At the **SONG** menu, use the cursor keys to highlight the **CREATE** option. Press **YES/ENTER**.



- 3 Use the **JOG/DATA** dial to select the **RESOLUTION** (audio bit depth) you want to use (16-bit or 24-bit). 24-bit captures a greater dynamic range of audio, but uses more disk space (ordinary audio CDs are 16-bit).
- 4 Use the **▲/▼** cursor keys to select the **KEEP MIXER** item, and then use the dial to select **ON/OFF**. If you select **ON**, the current song mixer settings (including effects and scene memories) are included in the new song. If you select **OFF**, the mixer settings are initialized when you create the new song.
- 5 Use the dial and the cursor keys to give the song a name up to 12 characters in length (see “Titling” on page 15).

Press **YES/ENTER** when you are done. The display shows the home screen.

Loading a song

To load a previously-saved song from disk (the current song will be written to disk automatically when the song is loaded):

- 1 Press the **MENU** key to open the **MENU** screen. Use the cursor keys to select the **SONG** item, and then press the **YES/ENTER** key.
- 2 At the **SONG** menu, use the cursor keys to highlight the **LOAD** option. Press **YES/ENTER**.

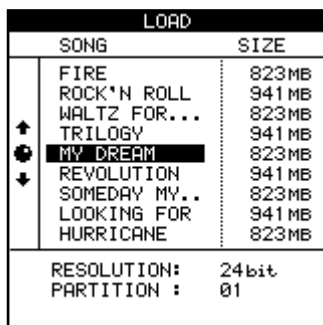

- 3 Select the song to be loaded. The current song is automatically saved, and the selected song is loaded from disk.

NOTE

This menu reads the songs stored on the currently-selected partition. If you are loading a song from another partition, you must select that partition first.

Saving a song

The function described here saves the song to disk.

- 1 Press the MENU key to open the MENU screen. Use the cursor keys to select the SONG item, and then press the YES/ENTER key.
- 2 At the SONG menu, use the cursor keys to highlight the SAVE option. Press YES/ENTER.

As the song is saved, appropriate messages are displayed. The current song will be reloaded after it has been saved, and you can resume work on it.

NOTE

When you load another song or shutdown the 2488MKII, the work done on the current song is automatically saved. However, power failures, accidentally unplugging power cords and other accidents that cause a loss of power may cause recent song data to be lost. For this reason, we encourage you to save your work frequently, especially after important recording, editing or other work.

Reverting to the previously saved version of a song

If you have saved a song and you want to return to the version of the song at the time it was last saved:

- 1 Press the MENU key to open the MENU screen. Use the cursor keys to select the SONG item, and then press the YES/ENTER key.
- 2 At the SONG menu, use the cursor keys to highlight the REVERT option. Press YES/ENTER.
- 3 The 2488MKII asks if you are sure. Press YES/ENTER if you want to throw away all changes since the last save operation, otherwise press NO/EXIT.

CAUTION

You will lose all recordings and edits made since the last save, and they will disappear from the undo list. This revert operation is not undoable. Be sure that the work you have done since the last save operation is really work that you do not want to keep before reverting to a previous version.

Erasing a song

To free up space on a disk partition, and delete a song or songs, you should perform the following operations:

- 1 Press the MENU key to open the MENU screen. Use the cursor keys to select the SONG item, and then press the YES/ENTER key.
- 2 At the SONG menu, use the cursor keys to highlight the ERASE option. Press YES/ENTER.

ERASE	
SONG	SIZE
✓ FIRE	823MB
ROCK'N ROLL	941MB
WALTZ FOR...	823MB
↑ TRILOGY	941MB
● MY DREAM	823MB
↓ REVOLUTION	941MB
SOMEDAY MY..	823MB
LOOKING FOR	941MB
HURRICANE	823MB
RESOLUTION: 24bit	
PARTITION : 01	
FREE AREA : 8521MB	

- 3 Select the song or songs to be erased using the dial to highlight the songs and the INSERT key to place a check mark beside them. If you select a song for erasure by accident, use the DELETE key to deselect it.
- 4 Press YES/ENTER to erase the selected song(s).
- 5 The 2488MKII asks you if you are sure. Press YES/ENTER if you really are sure that you want to erase these songs.

CAUTION

This operation cannot be undone. Erasing songs is a permanent operation. Always think carefully before you erase a song or songs.

NOTE

This menu can erase only the songs stored on the currently-selected partition. If you want to erase a song or songs from another partition, you must select it first.

If you have selected all the songs on a partition for erasure, a new song will automatically be created after all the existing songs have been erased.

7 – Recorder

Copying songs

As well as copying songs, so that you can work on another version of them, you can also use this menu item as a tool to back up songs to another partition (you can also back up to CD-R or personal computer, but this is a separate process).

- 1 Press the MENU key to open the MENU screen. Use the cursor keys to select the SONG item, and then press the YES/ENTER key.
- 2 At the SONG menu, use the cursor keys to highlight the COPY option. Press YES/ENTER.

COPY	
SONG	SIZE
✓FIRE	823MB
ROCK'N ROLL	941MB
WALTZ FOR...	823MB
↑ TRILOGY	941MB
● MY DREAM	823MB
↓ REVOLUTION	941MB
SOMEDAY MY..	823MB
LOOKING FOR	941MB
HURRICANE	823MB
RESOLUTION:	24bit
PARTITION :	01
TOTAL :	1646MB

- 3 Select the song or songs to be copied using the dial to highlight the songs and the INSERT key to place a check mark beside them.

If you select a song for copying by accident, use the DELETE key to deselect it.

- 4 When all the songs to be copied have been marked, press the YES/ENTER key. A list of all the partitions available currently is shown.
- 5 Use the dial to select the partition to which the selection will be copied, and press YES/ENTER.
- 6 The 2488MKII asks you if you are sure that you want to make the copy. Press YES/ENTER to continue with the operation, and NO/EXIT to cancel.

CAUTION

Copying a song may take some time. Be patient while the song is being copied, and take care not to power down the 2488MKII in the middle of a copy operation.

NOTE

If you copy a song to the partition where it was originally stored, it will be copied with the same title, so the list will contain two songs with the same title. If you want two copies of the same song on one partition, you should rename one of the copies immediately after the copy operation has been carried out.

When you make the selection for copying, only those songs in the currently-selected partition are listed. If you need to back up from many different partitions, you must select each partition in turn and then select the songs on the selected partition.

Erasing unneeded audio data from songs

In addition to audio data in the track and the “playlist,” songs may also contain “unused” audio data.

With the 2488MKII, audio data is not erased when a track is overwritten, but remains on the hard disk.

Audio data that has been completely overwritten is “unused.” The procedure below explains how to erase “unused” audio data.

As the illustration shows, if old audio data is not completely overwritten by new audio data, it will not be erased.

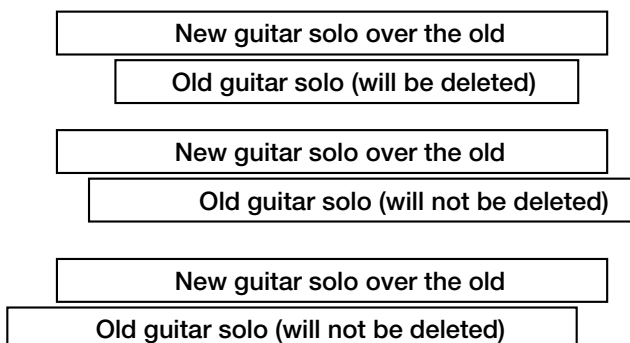

Unused audio data in virtual tracks that are not assigned to physical tracks can also be deleted (see “Virtual tracks” on page 66).

Use the following procedure to delete “unused” audio data and open more space on the hard disk. This operation cannot be undone.

- 1 Press the MENU key to open the MENU screen. Use the cursor keys to select the SONG item, and then press the YES/ENTER key.
- 2 At the SONG menu, use the cursor keys to highlight the DELETE UNUSED option. Press YES/ENTER.
- 3 The 2488MKII asks you if you are sure. If you want to delete all the unused portions of the song, press YES/ENTER. If you have second thoughts, press NO/EXIT.

CAUTION

This operation completely erases unused audio data in the song and cannot be undone. You can back up the song to CD-R or a personal computer, before performing this “cleanup” operation. If you change your mind later on, you can restore this backed up version.

Protecting a song

You can protect a song to prevent accidental changes.

When a song is protected, recording is not possible (the track **REC** keys are disabled), it cannot be edited using the track editing functions, and it cannot be erased, etc. using the **SONG** menu.

It is also impossible to set or edit mark points except the **IN** and **OUT** points for repeat operations, or to permanently reassign virtual tracks. Virtual tracks can be assigned for audition purposes, but not permanently saved.

In operations which show a list of available songs (for instance, loading a song), any protected songs have a small padlock icon beside the song title.

Only the currently-loaded song can be protected or unprotected at any one time (though, of course, songs stored on the disk can be stored as protected or unprotected).

- 1 Press the **MENU** key to open the **MENU** screen. Use the cursor keys to select the **SONG** item, and then press the **YES/ENTER** key.
- 2 At the **SONG** menu, use the cursor keys to highlight the **PROTECT** option. Press **YES/ENTER**.
- 3 Use the dial to set the protection **ON** or **OFF**, and press **YES/ENTER** to confirm the setting.

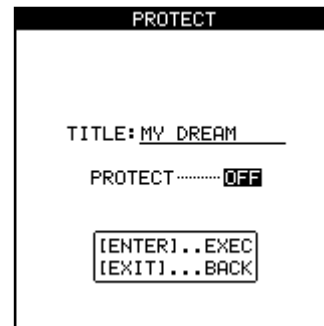

Transport controls

Most of the 2488MKII controls work the same as a normal tape recorder, but there are a few important differences, as outlined below.

Setting the playback position

The 2488MKII provides you with a number of ways to set the position from which playback starts when you press the **PLAY** key.

Some of these are described in the section on location operations. The ways of setting the playback point which involve the transport keys are described here.

Return to zero (RTZ)

During playback or recording, or when the transport is stopped, if you press the **REW** key while holding the **STOP** key, the playback position returns to the head of the song (the position defined as the **ABS** zero point). During playback or recording, playback or recording stops first.

- 1 Press and hold down **STOP**.
- 2 Press **REW**. Playback/Recording stops and the playback position returns to the zero point.

Last Recording Position (LRP)

This is an extremely useful feature that allows you to return instantly to the point where recording last started. You can use this in any of the following situations (these are examples, you may think of others for yourself):

- after you interrupt a bad take halfway through the recording and want to return instantly to the same position to retake.
- when you want to playback from the start of a take immediately after recording it.
- when you are recording a number of different tracks in turn, all to start from the same point.
- after a take, you may want to set the point where the take started as a reference location mark.

To return to the position where recording last started (from stop, play or record):

- 1 Press and hold down the **STOP** key
- 2 Press **F FWD**. Playback/recording stops, and the playback position returns to the point where recording last started.

7 – Recorder

Jog positioning

To position the playback point precisely, you can “jog” the playback position, using the dial. As you move backwards and forwards through the recording, you can hear the recorded sound at slow speed, either backward or forward, depending on the direction you are turning the dial.

NOTE

The 2488MKII can locate a position with an accuracy of 1/10 frame. The length of 1 frame depends on the frame rate (24–30 frames per second). At this speed, 1/10-frame accuracy is equivalent to 1/300-second – 1/240-second accuracy.

- 1 Position the playback point to the rough position where you want the final point to be.
- 2 Press and hold the STOP key and press the PLAY key. The transport enters JOG mode and the JOG indicator lights. The display shows a view of the waveform of the currently selected track at the current playback position.



- 3 Press the SELECT key of the track that you want to view (pressing the SELECT key of any of the stereo tracks [13/14, 15/16, 17/18, 19/20, 21/22, 23/24] alternates between viewing the odd- and even-numbered tracks). The display changes to the waveform of that track.
- 4 Use the ◀ and ▶ cursor keys to zoom out and in respectively horizontally.

In other words, pressing the ▶ key will increase the amount of space on the screen taken by a certain amount of time, and pressing the ◀ key will make the same amount of time take less space on the screen.

The three zoom levels available are: x 1, x 2 (allowing approximately single-frame accuracy in adjustment), and x 32 (allowing approximately an accuracy of about 10 sub-frames). The resolution is shown below the time display.

- 5 Use the ▲ and ▼ cursor keys to adjust the vertical scale (the way that the volume of the sound is shown).

The zoom levels here are x 1, x 2, x 4, x 8, x 16 and x 32. Pressing the ▲ key increases the vertical scaling of the display, and pressing the ▼ key decreases the scale.

TIP

If you cannot see any waveforms when you first enter this display, press the ▲ key to zoom the volume so that you can see the quiet passages.

- 6 Use the dial to move to the desired playback position.

You can monitor the “jogged” sound of the selected track through the monitoring system.

TIP

To move past the edge of the screen, press and hold the F FWD or REW keys to play the tracks forwards or backwards at normal speed for a rough position. When you release the keys, the playback will stop.

- 7 Press STOP (or YES/ENTER or NO/EXIT) to return to the home screen, with the playback position now being the point which has just been set.

The home screen now shows the playback position set with the JOG operation.

NOTE

Because only one track can be jogged at a time, only one track of a stereo pair can be heard at a time in this mode. If it is difficult to hear the track, you may want to monitor in mono (see “Monitoring” on page 36).

Fast forward and rewind

On a tape recorder, you can use the fast forward and fast rewind keys to spool through a tape. A disk recorder like the 2488MKII works in a somewhat different way.

The forward and rewind keys can be used in the following ways:

During playback When the unit is playing back material, if you press and hold either the **F FWD** or the **REW** key, the playback position moves forward or backward (depending on which key is being held down) at ten times the normal playback speed (as shown by the FF x10 or REW x10 in the home display).

At this time, playback is muted, and the **PLAY** indicator flashes.

When you release the **F FWD** or **REW** key, playback starts at the position which has been reached.

From the stop position When playback is stopped, you can press and hold the **F FWD** or **REW** key to start fast rewind or fast forward. The unit stops at the position where you release the key.

NOTE

You cannot perform this operation while recording.

Skipping to marks

If you briefly press and release the **F FWD** key, the transport skips to the next mark. If you briefly press and release the **REW** key, the transport skips to the preceding mark.

See “Mark functions” on page 51 for more about setting and using marks.

Recording

You can record after selecting the partition and the song. To start recording from the stopped state:

- 1 At least one track should be armed (press the **REC** key(s) of the track(s) on which recording is to take place). The **REC** key(s) start to flash.

Since tracks 13 to 24 are stereo tracks, they are always recorded simultaneously as paired tracks.

- 2 Press and hold down the **RECORD** key.
- 3 Press the **PLAY** key. Both the **PLAY** (green) and **RECORD** (red) indicators light, and the flashing **REC** indicator(s) light steadily.
- 4 Stop recording by pressing the **STOP** key.

NOTE

*When a track is recording or is armed to record (the track **REC** key is lit or flashing), its track number appears in inverse on the home screen, as shown in the illustration.*

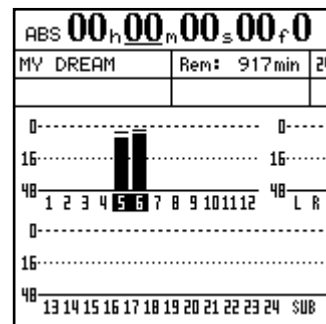

PUNCH recording

To drop into record mode while playing back:

- 1 Arm one or more tracks by pressing their **REC** keys. Their indicators start to flash.
- 2 Start playing back a song by pressing the **PLAY** key. The **PLAY** indicator will light.
- 3 Press the **RECORD** key. The **RECORD** indicator will light, and the **REC** indicators of the armed tracks will also light.

To end recording, press either the **STOP** key or the **PLAY** key (punch out).

NOTE

*At least one track must be armed before you start to record. It is not possible to enter a “record ready” mode and press the **REC** keys of tracks to start recording.*

7 – Recorder

Hands-free recording

You can also use a suitable foot switch (for example the TASCAM RC-30P) connected to the **PUNCH** jack on the front, to drop into record mode. When a track is armed, and playback is taking place, pressing the foot switch will change from playback mode to record mode.

When recording, pressing the foot switch will drop out of record mode into playback mode.

Undo recordings

You can “undo” recordings, (unlike on a tape recorder). Even if you accidentally record over important audio data, you can recover the original data by using the undo function. See “UNDO and REDO” on page 64 for details.

Rehearsing recording

Sometimes, even with the undo facilities and the virtual tracks of the 2488MKII, it may be useful for you to rehearse a take without actually committing anything to disk. This is probably most useful in auto punch operations (see “Auto punch operations” on page 55) but can be useful in other situations as well.

In a rehearsal, the monitoring and other operations and recording functions are the same as when recording, but the input signal, although passed through to a track, does not actually go to the disk.

To use the rehearsal mode, simply press the **RHSL** key so that the indicator is lit.

When actually “recording” in rehearsal mode, the **RECORD** indicator flashes, rather than lighting steadily, to show that the rehearsal is taking place.

IN, OUT, TO and FROM points

The IN, OUT, TO and FROM points are special marks used for various 2488MKII functions. Repeat playback and auto punch use the IN/OUT points, and track editing uses all four points (see “Repeat” / “Auto punch operations” on page 55 and “About track editing” on page 58).

Setting the IN, OUT, TO and FROM points

To set these points:

- 1 **Locate to the position where the IN, OUT, TO or FROM point is to be set.**
- 2 **Press and hold the LOCATE key, and then press the key you want to set (IN, OUT, TO or FROM).**

Set IN!, Set OUT!, Set TO! or Set FROM!
appears on the home screen.

NOTE

You cannot set these points while the repeat mode or auto punch mode is active.

Locating to the points

Simply press the IN, OUT, TO or FROM key to locate to the appropriate point.

Editing the IN, OUT, TO and FROM points

When the points have been set, it may be necessary to “trim” them, or to slip them backwards or forwards a little.

NOTE

These points cannot be edited when repeat mode is ON (the REPEAT indicator is lit).

Follow these procedures to “trim” (make small adjustments to) the positions of the IN, OUT, TO and FROM points:

- 1 Press the key (IN, OUT, TO or FROM) for the point you want to trim, to locate to that point.
- 2 Press and hold the STOP key and press the PLAY key. The JOG indicator lights. The display shows a view of the waveform of the currently selected track at the IN, OUT, TO or FROM point (depending on which was pressed).

- 3 Press the SELECT key of the track that you want to view. The display changes to the wave-form of that track.
- 4 Follow the instructions in “Jog positioning” on page 48 for zooming and moving the current jog position.
- 5 After setting the exact position, press and hold the LOCATE key and then press the key (IN, OUT, TO or FROM) you want to reset. The display returns to the home screen.

Press NO/EXIT to return to the home screen without setting the points (remember that YES/ENTER does not set these points).

Mark functions

In addition to the IN, OUT, TO and FROM points used for auto punch and editing, up to 999 marks can be set for every song.

These can be inserted, deleted, named and edited freely,

and they are stored with the song, allowing you to return at any time to a part of the song which you have marked as needing attention.

Inserting marks

To insert a mark point at the current position, press the INSERT key during playback, recording or when the transport is stopped to register a mark point at the current position.

Marks cannot be inserted, however, while fast forwarding or rewinding.

New marks are numbered sequentially in the order that they are recorded.

The mark title appears on the home screen under the time line to the right.

Active marks

If the song play position passes a mark during playback, the mark’s title appears on the screen. The mark whose title is shown on the screen is called the “active mark.”

This active mark can be accessed easily for titling, deletion and editing, as explained below.

■ Giving a title to the active mark

You can give a title to the active mark while playing back or recording, or while the playback is stopped.

- 1 When the active mark’s current title is displayed (this will be Mark XXX when the mark is first set), press the shifted TITLE key. The pop-up screen appears on the display, and you can edit the title as described in “Titling” on page 15.
- 2 When you press YES/ENTER after editing the name, the new name replaces the old mark name.

TIP

You can use the words here to enter mark titles quickly (see “User Words” on page 93).

■ Deleting the active mark

You can delete the active mark while playback is stopped, but you cannot delete it while playing back or recording (a popup message appears briefly if you try and you must press NO/EXIT to dismiss the message).

- 1 To delete the active mark, press the DELETE key. You do not have to confirm the deletion, but the words Clear mark! appear briefly on the display.
- 2 When the active mark has been deleted, the mark immediately before the active mark (if there is one) becomes the active mark, and its title is shown on screen.

NOTE

You cannot undo a mark deletion.

TIP

You can erase marks freely using the MARK LIST screen (see “Using the mark list” on page 53).

7 – Recorder

Editing the active mark

This process is sometimes referred to as trimming. This is a similar process to the jog positioning of the playback point (see “Jog positioning” on page 48), except that in this operation, the final position is stored as the position of the active mark.

You can edit the active mark when playback is stopped. You cannot edit the active mark when recording or playing back.

- 1 Make sure that the mark you want to edit is shown on the home display and that playback is stopped.
- 2 Press the TRIM key. The display shows TRIM and a view of the waveform of the currently selected track at the active mark.

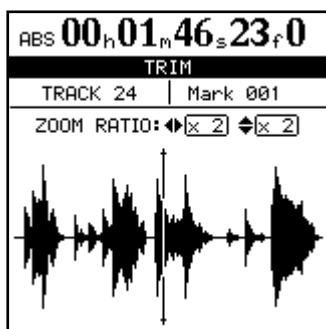

- 3 Press the SELECT key of the track that you want to view. The display changes to the waveform of that track.

Although the active mark applies to all tracks, if you have a track selected with nothing or little recorded on it at that point, it will be impossible to see or hear anything using this function.

- 4 Use the ◀ and ▶ keys to zoom out and in respectively horizontally. That is, pressing the ▶ key will increase the amount of space on the screen taken by a certain amount of time, and pressing the ◀ key will make the same amount of time take less space on the screen. The three zoom levels available are: x 1, x 2 at about single-frame accuracy, and x 32 at about 10-sub-frame accuracy (shown below the time display).

- 5 Use the ▲ and ▼ keys to adjust the vertical scale (the way that the volume of the sound is shown). The zoom levels here are x 1, x 2, x 4, x 8, x 16 and x 32. Pressing the ◆ key increases the vertical scaling of the display, and pressing the ▼ key decreases the scale.

NOTE

If you cannot see any waveforms when you first enter this display, press the ▲ key to zoom the volume so that you can see the quiet passages.

- 6 Use the JOG/DATA dial to move the playback position as you like. You can monitor the jogged sound of the selected track through the monitoring system.

NOTE

You cannot move the mark to a position before the previous mark or after the next mark.

- 7 To move past the edge of the screen, press and hold the F FWD and REW keys to play the tracks forwards or backwards at normal speed for a rough position. When you release the keys, the playback will stop.
- 8 Press YES/ENTER to accept the new position as the active mark value (the playback position is now the new position), and return to the home screen.
- 9 Press NO/EXIT to return to the home screen with the playback position being the point which has just been set, but the active mark value is unchanged.

Skip between marks

During playback or when the transport is stopped, press the F FWD or REW key briefly and release it to skip to the next or previous mark.

Using the mark list

Every time a mark is stored, it is entered into the list, and every time a mark is deleted, it is removed from the list.

Use the MARK LIST to locate, erase, and add titles to marks. Note that this list cannot be used to edit mark positions.

To see the list, press the LOCATE key:

MARK LIST	
TITLE	TIME
Mark 001	00:00:01:10
Mark 002	00:00:40:38
Mark 003	00:53:03:09

NOTE

Even when the time display on the home screen is shown in bars and beats, or the MTC time display is selected, the marks' time values are always shown using the absolute time values.

Items in the list are always sorted in time order, not the order of the mark point names or numbers.

■ Locating using the list

To locate using the mark list:

- 1 Press the LOCATE key.
- 2 Use the JOG/DATA dial (or ▲/▼ cursor keys) to select the desired mark.
- 3 Press the YES/ENTER key. The playback position jumps to the selected mark.

■ Titling using the list

- 1 Press the LOCATE key.
The MARK LIST screen appears.
- 2 Use the JOG/DATA dial (or ▲/▼ cursor keys) to select the mark whose title you want to edit.
- 3 Press the shifted TITLE key.
- 4 Give a title to the mark, using the procedure described in “Titling” on page 15.
- 5 When you press YES/ENTER to confirm the name, the screen returns to the list.

Two marks can have the same title (though it may be confusing), but they cannot have the same time value.

It is not possible to rename the IN, OUT, TO or FROM marks because they have special functions.

■ Erasing marks using the list

- 1 Press the LOCATE key.
The MARK LIST screen appears.
- 2 Use the JOG/DATA dial (or ▲/▼ cursor keys) to select the mark to erase.
- 3 Press the DELETE key to erase the selected mark.

7 – Recorder

Direct location

In this method, you use the cursor keys and the dial to locate to a specified position.

There are three modes in which the time can be shown on the home screen: ABS (the absolute time), MTC (MIDI Time Code) and BAR. The BAR time display is based on an internal tempo source map, or such as a standard MIDI file (SMF). See “Tempo and MIDI” on page 87 for details of these.

Direct location (i)

For the first two modes (ABS and MTC), the way to locate directly is as follows:

- 1 Make sure the transport is stopped. You cannot perform this direct location when playing back or recording.
- 2 If the “home” display is not shown, press the HOME key. There is an “underline” cursor at the top of the screen. If the top left of the screen does not show ABS or MTC (that is, it shows BAR), move the cursor to under BAR, and turn the dial counterclockwise until ABS or MTC is showing.
- 3 Use the left and right cursor keys to move the cursor to any of the following fields: hours (h), minutes (m), seconds (s), frames (s) or sub-frames (no indication on the display, though the value is shown).

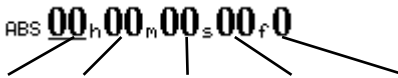

The diagram shows the time display with an underline cursor under the first digit of the hours field. The display is: ABS 00_h 00_m 00_s 00_f 0. Lines connect the labels 'Hours', 'Minutes', 'Seconds', 'Frames', and 'Sub-Frames' to their respective fields. The 'ABS' label is at the top left, and the '0' at the end is underlined.

- 4 Use the dial to increase or decrease the number over the cursor (in the illustration here, the cursor is under the “hours” value).

In the first two of these modes, you can locate to sub-frame accuracy. There are ten sub-frames in a frame, and the length of a frame depends on the frame rate set up in the sync operations, but is between 1/30 and 1/24 of a second. In the last mode, you can locate to beat accuracy.

- 5 If you increase a value past the maximum (for example, if you try to increase the “seconds” value over 59), the number will “wrap round;” that is, the “minutes” value will increase by one, and the “seconds” value will be set to 00.
- 5 When you change a value, the values on the top line will start to blink and will continue to blink for a few seconds.
- 6 Press YES/ENTER while the values are blinking to set the value, or PLAY to start immediate playback at that value. Also, if you do not press any keys or turn the dial for a few seconds, the values stop blinking, and the new time value that has been set becomes the current playback position.

If you press the NO/EXIT key (or the STOP key) while the values are blinking, the time value will be reset to the previous value before you started to edit it.

Direct location (ii)

As well as the ABS and MTC timings just described, it is possible to locate to a “musical” time, when the display shows bars (measures) and beats, and the 2488MKII is synchronized to a tempo map.

- 1 Make sure the transport is stopped. You cannot perform this direct location when playing back or recording.
- 2 If the “home” display is not shown, press the HOME key.
- 3 There is an “underline” cursor at the top of the screen. If the top left of the screen does not show BAR (that is, it shows MTC or ABS), move the cursor under the left field, and turn the dial clockwise until BAR is shown.

- 4 Use the cursor keys to move the cursor to either of the following: bars (3 digits), or beats (2 digits). The tempo value cannot be altered here—it is set by the tempo map.

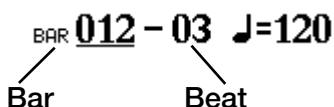

The diagram shows the BAR display with an underline cursor under the first digit of the bars field. The display is: BAR 012 - 03 ♩=120. Lines connect the labels 'Bar' and 'Beat' to their respective fields.

- 5 Use the dial to increase or decrease the number over the cursor (in the illustration, the cursor is under the “bars” value).

If you increase the “beats” value past the maximum number of beats on a bar at that point in the tempo map, the number will “wrap round;” that is, the “bars” value will increase by one, and the “beats” value will be set to 01.

- 6 When you change a value, the values on the top line will start to blink and will continue to blink for a few seconds.
- 7 Press YES/ENTER while the values are blinking to set the value, or PLAY to start immediate playback at that value. Also, if you do not press any keys or turn the dial for a few seconds, the values stop blinking, and the new time value that has been set becomes the current playback position.

If you press the NO/EXIT key (or the STOP key) while the values are blinking, the time value will be reset to the previous value before you started to edit it.

Repeat

You can repeat playback between the IN and OUT points by pressing the REPEAT key so that the indicator lights. Repeat recording is handled using the auto punch facility (see “Auto punch operations” on page 55).

Setting the repeat interval

On a tape recorder repeating a section, there is a delay while the tape rewinds. The “instant rewind” of a disk recorder can give you no time to prepare your fingers, take a breath, etc. ready for the next take.

The 2488MKII allows you to set a time between reaching the OUT point and starting to replay from the IN point again: from 0 seconds to 9.9 seconds.

- 1 Press and hold the REPEAT key so that a pop-up screen appears.

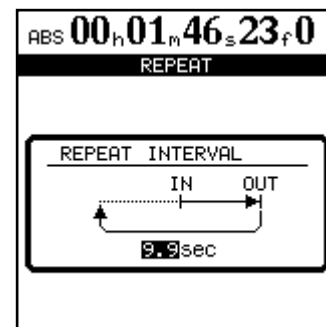

- 2 Use the dial to set the interval. Pressing YES/ENTER returns to the home screen.

Auto punch operations

Punch operations allow you to start and stop recording at predefined points, and these can be automated, as described here.

When auto punch recording begins, playback starts at pre-roll point some time before recording is due to start, the punch-in point is reached, and recording starts. When the punch-out point is reached, recording stops, and playback continues until the post-roll point.

In addition, when you perform an auto punch recording, during the pre-roll period, you hear what has previously been recorded, together with the signal source; during the punch recording itself, you hear the signal source alone; and for the post-roll period, you hear the previously recorded material and the signal source together.

The 2488MKII allows all of this to happen in rehearsal mode as well as in an actual recording mode. The rehearsal mode allows you to simulate the punch recording, both to practise the actual take, and also to check punch points before recording actually begins.

You can also use the repeat function together with the auto punch operations, allowing you to make repeated rehearsals of a punch section, as well as repeated takes of the same section (multi-takes) or when you are recording, repeated recordings can be used as multi-takes. With multi-take recording, you can choose the best recording after recording many takes, one after the other.

7 – Recorder

Setting the punch points

The 2488MKII provides three different punch settings.

- 1 With at least one track armed (the REC indicator flashing), and playback stopped, press the AUTO PUNCH key:

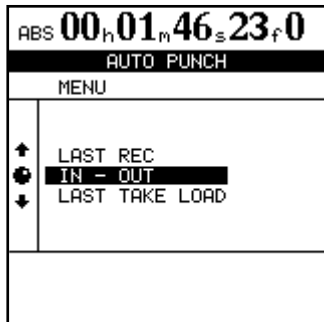

- 2 Select one of the three options, explained below, using the dial or cursor keys to move the cursor, and the YES/ENTER key to confirm the selection (NO/EXIT exits this screen without making any settings).
- 3 When the selection has been made, the AUTO PUNCH indicator lights, and the home display shows AUTO.

NOTE

It is not strictly necessary to have a track armed when you first press the AUTO PUNCH key, but this is probably the most logical way to work.

Checking the punch points

When the punch points have been set, you can press the PLAY key. The home display shows CHECK, and the playback starts at the pre-roll point. It continues to the post-roll point.

If the punch positions are not what you want, you can press the AUTO PUNCH key to turn off the punch mode, and reset the punch points as described above.

LAST REC This option sets the start and end points of the last recording (or recording rehearsal) as the punch in and punch out points.

IN - OUT This uses the IN and OUT points as the punch-in and the punch-out points. The first of these points will be used as the punch-in point, and the second as the punch-out point, even if the OUT point is before the IN point.

LAST TAKE LOAD This option appears after auto punch recording if no other recording, track editing, virtual track assignment or undo/redo operation has occurred. It allows you to select the takes from this punch session, in the same way as described later in this section. In addition, you can reselect the previously recorded take without conducting a new recording.

Rehearsing the punch

Although you do not have to use the rehearsal feature (see “Rehearsing recording” on page 50) with the auto punch, it’s probably a good idea to rehearse most punch recordings a few times before making a take.

- 1 With the AUTO PUNCH indicator lit, and a track armed, press the RHSL (rehearsal) key. The indicator lights.
- 2 Press and hold down the RECORD key and press the PLAY key.
 - The display shows TAKE.
 - Playback starts at the pre-roll point. Both the input source and previously-recorded material can be monitored.

Set the pre-roll and post-roll time on the RECORDER screen of the PREFERENCE menu (see “Recorder preferences” on page 93), but you must exit the auto punch mode first by pressing the AUTO PUNCH key so that the indicator goes out. If you the punch points and pre and post-roll times are what you want, you should proceed to the rehearsal stage, as described below.

- When playback reaches the punch-in point, the monitored signal on the armed track(s) is muted. The RECORD indicator flashes (to show that it is a rehearsal).
- When playback reaches the punch-out point, the recorded material is added to the monitored signal. The RECORD indicator goes out.
- Playback continues to the post-roll point and stops.

If you press the REPEAT key before the rehearsal, so that the indicator is lit (as well as the AUTO PUNCH and RHSL indicators), the rehearsal process will repeat until you press the STOP key. There is about a second’s interval between the post-roll and the restarting of the rehearsal at the pre-roll point. You cannot change this interval.

Recording the punch

When you are happy with the rehearsed punch material, you record the punch in the following way:

- 1 Press the RHSL key so that the indicator goes out.
- 2 Press and hold the RECORD key and press the PLAY key.
 - The display shows TAKE.
 - Playback starts at the pre-roll point. Both the input source and previously-recorded material can be monitored.
 - When playback reaches the punch-in point, the monitored signal on the armed track(s) is muted. The RECORD indicator lights steadily.

- When playback reaches the punch-out point, the recorded material is added to the monitored signal. The RECORD indicator goes out.
- Playback continues to the post-roll point and stops.

If the REPEAT indicator is lit, the punch recording will continue to repeat (up to 99 times) until you press STOP, allowing you to select from a list of “multi-takes” (see “Checking the take” below).

The time between repeat takes is about one second. You cannot change this time.

Checking the take

After auto punch recording is complete, the TAKE LIST screen shown below appears.

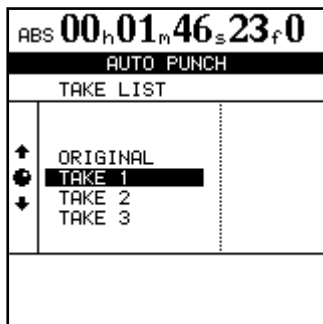

You can make an instant check of the take by following the procedure below.

When the take is complete, a screen similar to the following appears:

- The screen above shows three takes and the original track.
- Use the dial to highlight a take from the list, including the original track before the punch was started.
- Press PLAY to check the highlighted take by playing it back (starting at the pre-roll point, and continuing to the post-roll point).
- If you are happy with the take, you can move to the next stage below (“After finishing the punch” below).
- If you want to record another take, press and hold RECORD, and press PLAY.

After finishing the punch

When you have finished the auto punch recording:

- 1 Use the dial to highlight the take which you feel is the best (or if none of them was any good, select ORIGINAL, which is the unchanged version).
- 2 Press YES/ENTER to select the selected take (or the original version). A pop-up display asks you if you are sure that you want to use the take.
- 3 Press YES/ENTER if you are sure, but if you change your mind to select another take, press NO/EXIT.

NOTE

You must select one of the takes or the original to exit auto punch mode.

The recording between the punch-in and punch-out points is now replaced by the selection. The AUTO PUNCH indicator goes out.

If you change your mind

Like recording, an auto punch operation is undoable. It is shown in the HISTORY list on the UNDO/REDO screen (“UNDO and REDO” on page 64).

In addition, as we mentioned earlier, the third choice when you press the AUTO PUNCH key, LAST TAKE LOAD, allows you to select any of the multi-takes from the last punch session.

However, if you have recorded anything else, performed an undo or redo operation, or made any track editing opera-

tions, the LAST TAKE LOAD option is not available when you press the AUTO PUNCH key.

NOTE

Even if you undo the recording that has overwritten the list of multi-takes, the multi-take list will not be available to you after the undo.

7 – Recorder

Bouncing tracks

Like many multitrack recorders, the 2488MKII allows you to “bounce” a collection of recorded tracks to a smaller number of tracks. This allows you to record more than 24 tracks (but once bounced onto a track or pair of tracks, the original tracks cannot be separated again).

With the 2488MKII, any track or tracks other than the bounce destination track can be a source track. Therefore, when bouncing to a stereo track, the remaining 22 tracks can be used as recording sources. Likewise, a mono bounce track can use the other 23 tracks as sources.

In bounce mode, the recording source track signals pass from the mixer channels, through the sub mix bus, to the bounce track.

While you are performing a bounce operation, you cannot use the sub mixer facility (“Sub mixer” on page 35).

Making a bounce mix

- 1 Press the BOUNCE key. The key lights, and BOUNCE MODE appears on the home screen.
- 2 Select the destination. Press the REC keys for a single track (mono bounce), or two tracks (or a stereo track) for a stereo bounce.

NOTE

In bounce mode, until you press the REC key for the bounce destination, no audio signal is sent to the STEREO OUTPUT or the MONITOR OUTPUT.

- 3 Adjust the source tracks’ levels, EQ and pan positions, etc. for the bounce mix. Press the MUTE keys (or lower the faders) on tracks that you do not want to bounce.

NOTE

When you monitor the bounce, you are monitoring the bounce destination. If any EQ etc. is applied to the destination track(s), this is added to the signal you are monitoring. You may therefore want to make sure that the EQ is turned off on the destination tracks.

- 4 While watching the level meter of the bounce destination track on the home screen, use the SUB fader to adjust the final recording level (the sub mix bus output level becomes the bounce mix recording level).

NOTE

While bouncing, the bounce destination track fader and STEREO fader affect the monitoring volume, but they do not affect the recording level.

- 5 When the bounce is done, press the BOUNCE key again to return to ordinary recording mode.

TIP

If you press the sub mixer section SELECT key to open the SUB MIXER screen, you can confirm that REC is selected as the sub mix bus assignment destination.

By assigning input channels (A–H) to the sub mixer during track bounce, input signals can also be sent to the bounce destination track (see “Sub mixer” on page 35).

About track editing

One of the most useful features of a disk-based recorder such as the 2488MKII is the ability to edit material easily. When working with a stereo tape recorder in the past, the usual editing method involved a white pencil, a razor blade and sticky splicing tape. This was not an easy process, and was very difficult to undo if there were any mistakes.

The 2488MKII allows you to edit songs, copying and moving material from one part of a song to another. This editing is known as non-destructive editing, meaning that the operation does not actually destroy data, and you can undo mistaken editing operations easily.

If you have ever used a word-processor on a computer, you will probably find most of the 2488MKII’s editing operations pretty simple. If you have never used a computer, the 2488MKII’s editing operations are nothing to be scared about—just read through this section to see how it all works.

IN, OUT, TO and FROM

The IN, OUT, TO and FROM points are used for editing operations (the IN and OUT points are also used for the previously described auto punch and repeat functions).

See “IN, OUT, TO and FROM points” on page 50 for how to set and trim (adjust) these points.

The IN point is the start of the section to be edited at the beginning of track editing.

The OUT point is the end of the section to be edited at the beginning of track editing.

The TO point is the destination for many editing operations, including copy and paste, copy and insert, move and paste, and move and insert.

In COPY FROM→TO editing, the FROM point is a point set within the section to be copied. See “COPY FROM→TO” on page 60 for details.

NOTE

If the interval between IN and OUT points is less than 0.5 seconds, the popup screen does not appear and you cannot use COPY, MOVE or other editing functions. Increase the interval between IN and OUT points to more than 0.5 seconds to use these functions.

Entering the edit mode

- 1 Make sure that the 2488MKII is stopped (not playing back or recording).
- 2 Press the EDIT TRK key (below the monitor controls).
- 3 Use the dial to highlight the track editing function you will be using and press the YES/ENTER key.
- 4 Select the appropriate values, as described below.
- 5 Press YES/ENTER to perform the operation, or NO/EXIT to exit without performing the operation.

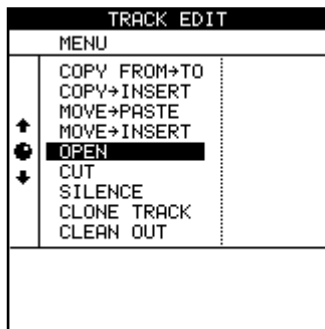

Track editing functions

The track editing functions available on the 2488MKII are:

- COPY→PASTE
- COPY FROM→TO
- COPY→INSERT
- MOVE→PASTE
- MOVE→INSERT
- OPEN
- CUT
- SILENCE
- CLONE TRACK
- CLEAN OUT

See the sections below for details of how to use these functions.

TIP

These operations can be undone (see "UNDO and REDO" on page 64). For example, even if you have erased an entire track, you can easily restore it.

Although you cannot use virtual tracks as sources for copy and move operations, you can assign a virtual track temporarily to a physical track for track editing operations and then reassign it when you are finished (see “Virtual tracks” on page 66).

7 – Recorder

COPY → PASTE

This function takes the section of a track or tracks marked by the IN and OUT points, copies it, and places it at the TO point on the chosen track or tracks. The original source is left unchanged.

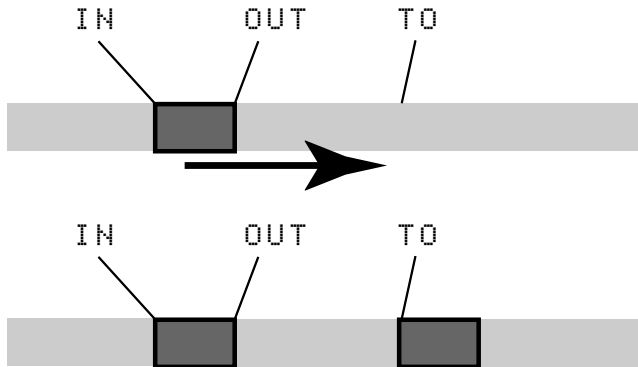

The copy operation overwrites anything which is already recorded at the destination. The destination is the same length as it was before the operation.

You can copy the section more than once in one operation.

COPY FROM → TO

This function copies the audio material from between the IN and OUT points on the copy source track and pastes it to the copy destination track. In this operation, the FROM point is set within the section to be copied. When this section is pasted, this FROM point is relocated to the destination TO point. This function is useful when you need to align a specific moment in a section, rather than the beginning or end of the section, to a specific time.

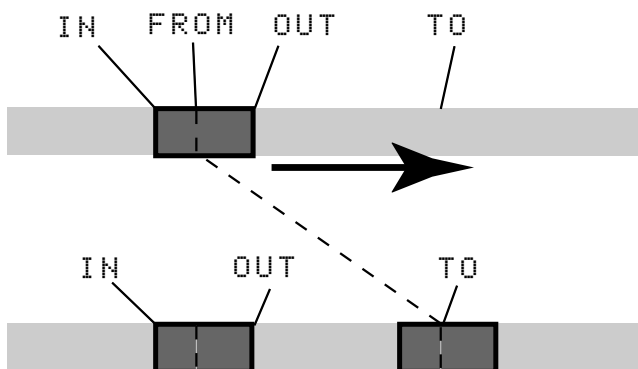

The copy source does not change after this operation.

This operation overwrites anything that is recorded at the destination. The length of the copy destination track does not change.

You can change the following values:

Src.Trk This sets the source track or tracks from which the section is copied. Choose 1 through 24 to select an individual track. Choose 1/2, 3/4, 5/6 etc. to select a pair of tracks. Choose 1-24 to select all tracks.

Dst. Trk This sets the destination track or tracks to which the selected section is pasted. What you can select here depends on what you have selected for the source track. If you have selected a single track, you can select tracks 1 through 24 here. If you have selected a pair of tracks (for instance, 1/2), you can only select track pairs here. If you have selected all tracks (1-24), then 1-24 is the only option available to you here.

Times This is the number of times that the selected section is pasted into the destination track or tracks. You can set this value from 1 to 99.

Press **YES/ENTER** to perform the operation or **NO/EXIT** to leave this screen.

This operation has the three following parameters:

Src.Trk This selects the source track from which the section is copied. Choose 1 through 24 to select an individual track. Choose 1/2, 3/4, etc. to select a pair of tracks. Choose 1-24 to select all tracks.

Dst.Trk This sets the destination track to which the selection is copied. Selection options here depend on what you have selected for the Src.Trk. If you have selected a single track, you can select tracks 1 through 24 here. If you have selected a pair of tracks (for instance, 1/2), you can only select track pairs here (1/2, 3/4, etc.). If you have selected all tracks (1-24), then 1-24 is the only option available here.

Times This is the number of times that the selected section is pasted into the destination track or tracks.

You can set this value from 1 to 99.

NOTE

The COPY→PASTE operation pastes the material after the TO point continuously without gaps, while COPY FROM→TO maintains the amount of time between the FROM point and TO point when audio is pasted.

Moreover, only this function appears in the Undo list as COPY→PASTE.

After setting the parameters, press the **YES/ENTER** key to perform the operation or the **NO/EXIT** key to leave this screen.

COPY → INSERT

This function takes the section of a track or tracks marked by the IN and OUT points, copies it, and places it on the chosen track or tracks, inserting it as new material, starting at the TO point.

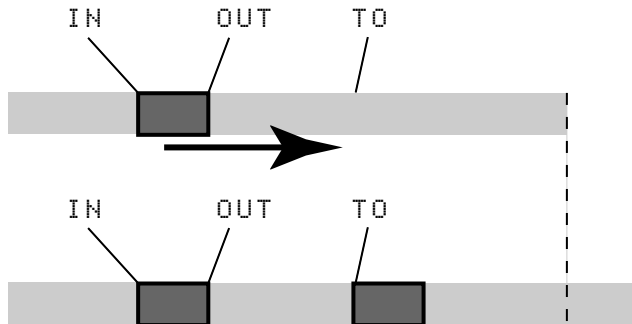

The original source is left unchanged.

The insert operation adds the copy source audio material after the TO point. Nothing is overwritten on the destination, as any existing material following the TO point is moved to the end of the newly-inserted section. The destination is longer than it was before the operation.

You can copy the section more than once in one operation.

You can change the following values:

Src. Trk This sets the source track or tracks from which the section is copied. Choose 1 through 24 to select an individual track. Choose 1/2, 3/4, 5/6 etc. to select a pair of tracks. Choose 1-24 to select all tracks.

Dst. Trk This sets the destination track or tracks into which the selected section is inserted. What you can select here depends on what you have selected for the source track. If you have selected a single track, you can select tracks 1 through 24 here. If you have selected a pair of tracks (for instance, 1/2), you can only select track pairs here. If you have selected all tracks (1-24), then 1-24 is the only option available to you here.

Times This is the number of times that the selected section is inserted (end-to-end) in the destination track or tracks. You can set this value from 1 to 99.

Press **YES/ENTER** to perform the operation or **NO/EXIT** to leave this screen.

MOVE → PASTE

This function takes the section of a track or tracks marked by the IN and OUT points, and moves it to the chosen track or tracks, starting at the TO point.

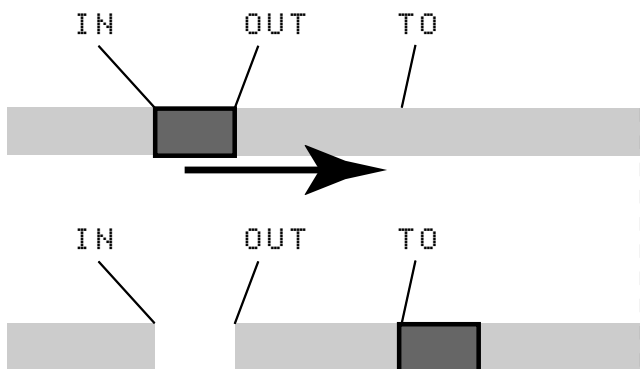

After the operation, the selected section of the source between the IN and OUT points is replaced by silence.

This operation overwrites anything which is already recorded at the destination. The destination is therefore the same length as it was before the operation.

You can change the following values:

Src. Trk This sets the source track or tracks from which the section is taken. Choose 1 through 24 to select an individual track. Choose 1/2, 3/4, 5/6, etc. to select a pair of tracks. Choose 1-24 to select all tracks.

Dst. Trk This sets the destination track or tracks to which the selected section is moved. What you can select here depends on what you have selected for the source track. If you have selected a single track, you can select tracks 1 through 24 here. If you have selected a pair of tracks (for instance, 1/2), you can only select track pairs here. If you have selected all tracks (1-24), then 1-24 is the only option available to you here.

Press **YES/ENTER** to perform the operation or **NO/EXIT** to leave this screen.

7 – Recorder

MOVE → INSERT

This function takes the section of a track or tracks marked by the IN and OUT points, and moves it to the chosen track or tracks, inserting it as new material, starting at the TO point.

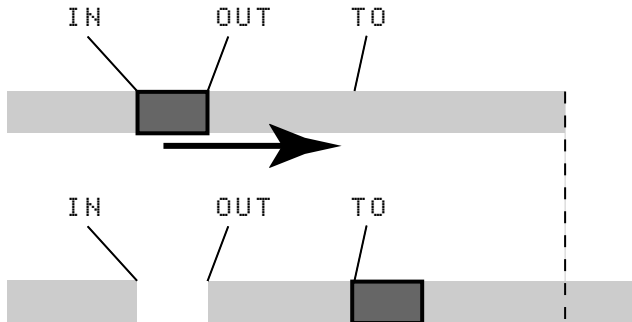

After the operation, the selected section of the source between the IN and OUT points is replaced by silence.

The insert operation adds the selected section as new material to the destination. Nothing is overwritten on the destination, as any material following the TO point is moved to the end of the newly-inserted section. The destination is therefore longer than it was before the operation.

You can change the following values:

Src. Trk This sets the source track or tracks from which the section is taken. Choose 1 through 24 to select an individual track. Choose 1/2, 3/4, 5/6, etc. to select a pair of tracks. Choose 1-24 to select all tracks.

Dst. Trk This sets the destination track or tracks into which the selected section is inserted. What you can select here depends on what you have selected for the source track. If you have selected a single track, you can select tracks 1 through 24 here. If you have selected a pair of tracks (for instance, 1/2), you can only select track pairs here. If you have selected all tracks (1-24), then this is the only option available to you here.

Press **YES/ENTER** to perform the operation or **NO/EXIT** to leave this screen.

OPEN

This function “opens up” a silent gap between the IN and OUT points on the chosen track or tracks.

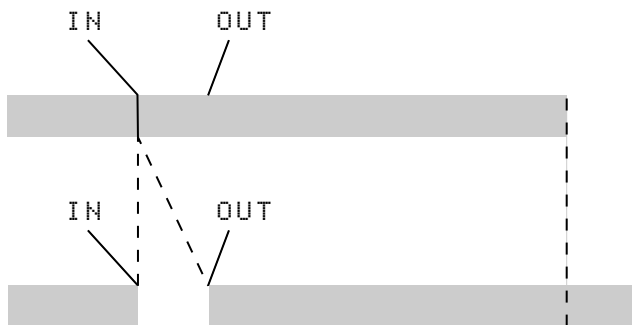

The source and destination are the same, and after the operation, the track is split at the IN point, with the material which followed the IN point now moved to follow the OUT point. The result is therefore longer than the original.

There is only one value that you can change:

Src. Trk Select an individual track (1 through 24), a pair of tracks (1/2, 3/4, etc.), all of the tracks (1-24) or all the virtual tracks (ALL).

Press **YES/ENTER** to perform the operation or **NO/EXIT** to leave this screen.

CUT

In this operation the audio material after the OUT point is moved forward to the IN point.

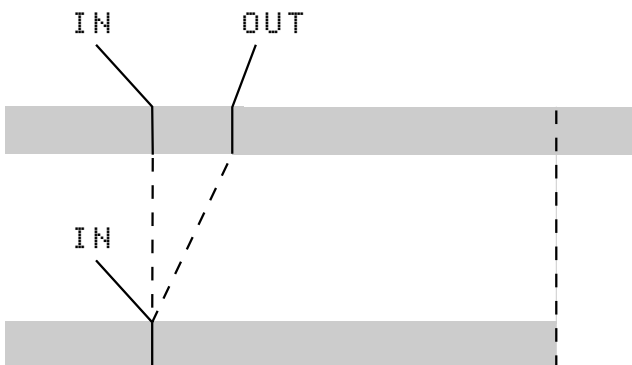

The source and destination are the same, and after the operation, the material which followed the OUT point now moved to follow the IN point. Material which was between the IN and OUT points is deleted. The result is therefore shorter than the original.

There is only one value that you can change:

Src. Trk Select an individual track (1 through 24), a pair of tracks (1/2, 3/4, etc.), all of the tracks (1-24) or all the virtual tracks (ALL).

Press **YES/ENTER** to perform the operation or **NO/EXIT** to leave this screen.

SILENCE

This function is equivalent to recording silence between the IN and OUT points on the chosen track or tracks.

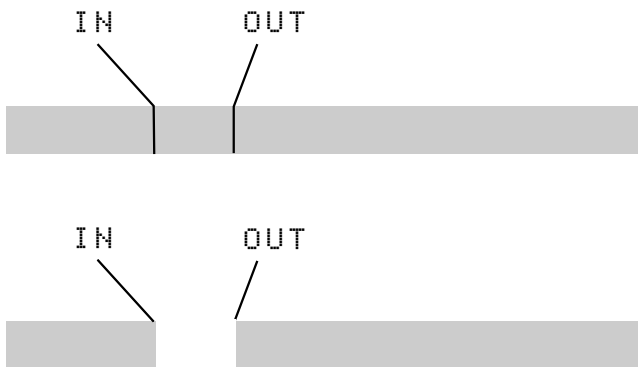

No material is added or deleted, and the length of the result is therefore the same as that of the original.

There is only one value that you can change:

Src. Trk Select an individual track (1 through 8), a pair of tracks (1/2, 3/4, 5/6, etc.), or all the tracks (1-24).

Press **YES/ENTER** to perform the operation or **NO/EXIT** to leave this screen.

CLONE TRACK

This copies a track or pair of tracks to another track or pair of tracks. The IN and OUT points do not have any meaning here.

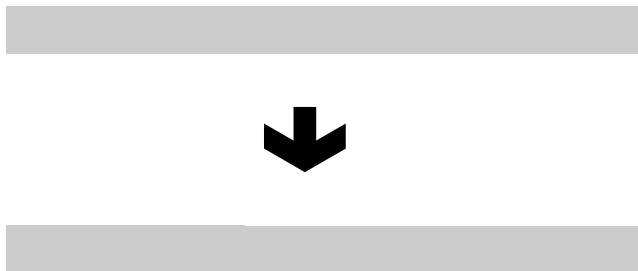

There are two values that you can change:

Src. Trk Select an individual track (1 through 24), or a pair of tracks (1/2, 3/4, 5/6, etc.) or the MASTER stereo track.

Dst. Trk This sets the destination track or tracks to which the source track is cloned. What you can select here depends on what you have selected for the source track. If you have selected a single track, you can select tracks 1 through 24 here. If you have selected a pair of tracks (for instance, 1/2 or MASTER), you can only select track pairs (1/2, 3/4, etc.) here.

Press **YES/ENTER** to perform the operation or **NO/EXIT** to leave this screen.

If you try to select the same track as a destination that you have selected as the source, when you press the **YES/ENTER** key, a pop-up message will appear.

Redo the operation with a different set of tracks.

CLEAN OUT

This deletes all the audio material in the selected track or tracks.

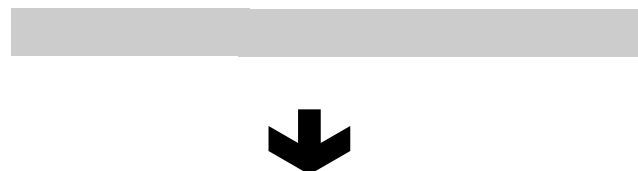

The IN and OUT points do not have any meaning here.

There is only one value that you can change:

Src. Trk Selects the tracks for erasing the audio data. You can select a single track (1 through 24), a pair of tracks (1/2, 3/4, etc.), all the tracks (1-24) or virtual tracks that have not been assigned to physical tracks (Vtrack).

Press **YES/ENTER** to perform the operation or **NO/EXIT** to leave this screen.

7 – Recorder

UNDO and REDO

Unlike a tape recorder, but like most word-processors, you can undo your mistakes (the 2488MKII remembers up to the last 999 operations you perform in each song). What is more, you can undo your undo operations (redo).

The operations that you can undo are:

- The different track editing functions described in this section
- Recording operations (including track bounce)
- Auto punch operations
- Mastering operations
- Import of WAV files

In addition, all these operations are stored as part of the song on the disk; even when you turn the machine off, the history of all the previous operations is stored ready for next time.

What this means is that you can finish your work for the day, come back in the morning with fresh ears, and decide that maybe you did not want that overdub after all. With the 2488MKII, this is no problem.

Undoing and redoing actions

- 1 Press the UNDO/REDO key and a list of the operations that you have done since the start of the song is shown on screen:

The first action (START UP) at the bottom of the display is numbered 0, and all the actions after this (above this) are then numbered in order.

UNDO/REDO	
HISTORY	No.
RECORDING	8
AUTO PUNCH	7
→AUTO PUNCH	6
AUTO PUNCH	5
← COPY+PASTE	4
RECORDING	3
RECORDING	2
RECORDING	1
START UP	0

- 2 Use the dial to scroll to the step to which you want to go back.
- 3 Press YES/ENTER, to return to the point in your work just before you made your mistake.

You can also redo an action that you have undone in exactly the same way.

TIP

As well as using the dial to scroll through the list, you can also use the UNDO /REDO key to position the cursor automatically at the event before or after the current event.

If you press the UNDO key (unshifted), the cursor moves to the event immediately before the current event.

Press YES/ENTER to undo the last event.

If you press REDO (UNDO when the SHIFT indicator is lit), the cursor moves to the event immediately following the current event (i.e. the last action that has been undone). Press the YES/ENTER key to redo this action.

NOTE

Recording, track editing, or any other operation after an undo or redo operation, clears the list of redoable actions (i.e. those actions which have been undone).

An undo/redo example

Here's an extremely simplified example that extremely unlikely that you'd work this way, but it shows the principles involved:

```
>RECORDING 12 Lead vocal 3rd take
RECORDING 11 Lead vocal 2nd take
AUTO PUNCH 10 Lead vocal correction
RECORDING 9 Lead vocal
AUTO PUNCH 8 Retake of guitar solo bridge section
RECORDING 7 Guitar solo
RECORDING 6 Piano (second part)
RECORDING 5 Piano
RECORDING 4 Scratch vocal take
RECORDING 3 Bass line
COPY->PASTE 2 Copy and paste drum loop
RECORDING 1 Basic drum loop
START UP 0 Start song
```

This is the history of a recording session so far. Suppose that you decide that items 11 and 12 in the list are not needed (in other words, the first take (9) with its correction (10) have been overwritten by 11 and 12, but you feel that the original take (9) with its correction (10) has more energy, so you want to retrieve it:

- 1 Press the UNDO key.
- 2 Use the dial to scroll down to the step to which you want to go back (here it's 10).
- 3 Press YES/ENTER. All steps up to the selected step are now undone.

Now you have the track back again. If you press the UNDO key, you'll see that there's a check mark beside 10 - this shows that this is the "undo mark."

```
RECORDING 12 Lead vocal 3rd take
RECORDING 11 Lead vocal 2nd take
>AUTO PUNCH 10 Lead vocal correction
RECORDING 9 Lead vocal
AUTO PUNCH 8 Retake of guitar solo bridge section
RECORDING 7 Guitar solo
RECORDING 6 Piano (second part)
RECORDING 5 Piano
RECORDING 4 Scratch vocal take
RECORDING 3 Bass line
COPY->PASTE 2 Copy and paste drum loop
RECORDING 1 Basic drum loop
START UP 0 Start song
```

The actions above this "undo" line are undone.

Notice that we can still see items 11 and 12. This is because we can still redo them, if we decide that the first vocal take (9 and 10) was not so great after all.

To redo them is just as simple as undoing them: press the UNDO key, highlight the step to which you want to return, and press YES/ENTER.

Items above the "undo" line are visible and you can redo them until you perform another action after the undo operation. For instance, if you decided that you wanted to have another go at repairing the lead guitar bridge...

You could undo all items up to item 7:

```
RECORDING 12 Lead vocal 3rd take
RECORDING 11 Lead vocal 2nd take
AUTO PUNCH 10 Lead vocal correction
RECORDING 9 Lead vocal
AUTO PUNCH 8 Retake of guitar solo bridge section
>RECORDING 7 Guitar solo
RECORDING 6 Piano (second part)
RECORDING 5 Piano
RECORDING 4 Scratch vocal take
RECORDING 3 Bass line
COPY->PASTE 2 Copy and paste drum loop
RECORDING 1 Basic drum loop
START UP 0 Start song
```

...and then re-record the guitar bridge.

After this, though, if you wanted to restore the vocal tracks which we'd recorded, you would not be able to. The new recording would replace everything above the line.

All the previous items are now erased:

All the later actions are permanently erased

```
>AUTO PUNCH 8 Retake of guitar solo bridge section
RECORDING 7 Guitar solo
RECORDING 6 Piano (second part)
RECORDING 5 Piano
RECORDING 4 Scratch vocal take
RECORDING 3 Bass line
COPY->PASTE 2 Copy and paste drum loop
RECORDING 1 Basic drum loop
START UP 0 Start song
```

7 – Recorder

Virtual tracks

Up to now, we have described the 2488MKII as a 24-track recorder because it can playback up to 24 tracks simultaneously. In fact, however, each song may contain up to 250 tracks, which we call “virtual tracks.” Up to 24 of these virtual tracks may be assigned to playback tracks 1–24, which are called “physical tracks.” The 24 virtual tracks assigned to these physical tracks are available for recording and playback.

Throughout this User's Guide, when we use the expression “track,” we are referring to a virtual track that is assigned to a physical track.

Use the virtual tracks to record multiple takes of lead vocals, improvised solos and other parts and then select the best takes afterwards. After recording a take, you can assign a different virtual track to the same physical track to record another take on the same physical track. By repeating this process, you can use multiple virtual tracks to hold different takes, and select the take or takes that you want afterwards.

Here, we pick the best takes from the virtual tracks and assign them to our playback tracks.

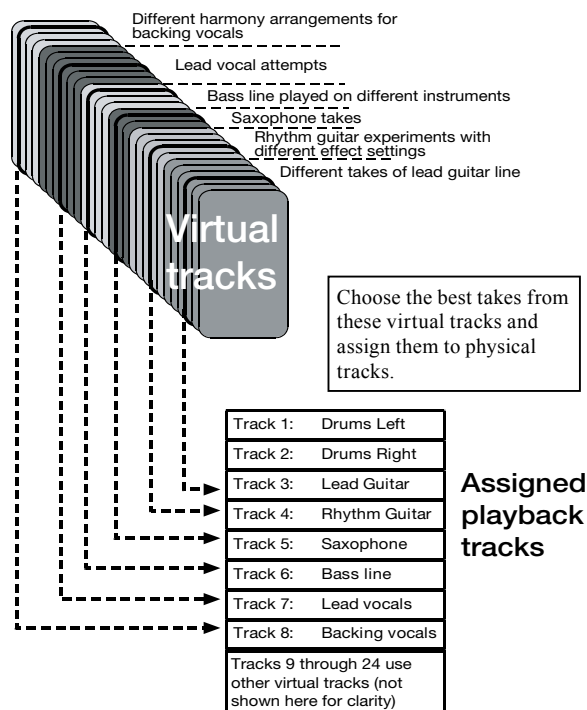

Tracks 9 through 24 use other virtual tracks (not shown here for clarity). Here, we pick the best takes from the virtual tracks and assign them to our playback tracks.

Virtual tracks are mono tracks. You need to assign one virtual track to each track of a stereo pair.

To assign a virtual track to a physical track:

- 1 Press the shifted VIRT TRK key.

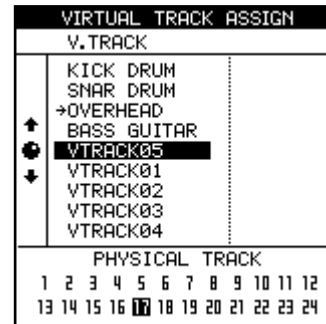

NOTE

When you create a new song, virtual tracks 1–24 are initially assigned to physical tracks 1–24.

- 2 Use the track SELECT keys or the (◀ and ▶) keys to select the physical track for assigning a virtual track. The inverted number at the bottom of the screen shows the selected physical track.

Repeated pressing of the stereo channel SELECT keys (13/14 through 23/24) changes between the odd and even numbered channels of that pair.

- 3 Use the dial to choose which virtual track will be assigned to the physical track and become active.

When the VIRTUAL TRACK ASSIGN screen is open, by pressing the MENU (TITLE) key in SHIFT mode, you can give the highlighted virtual track a name (see “Titling” on page 15).

- 4 Press YES/ENTER to make the assignment.

The virtual track selected in procedure 3 is assigned to the physical track.

Press NO/EXIT to exit the track assignment screen without actually making the assignment.

NOTE

During step 4 above, if you press the PLAY key instead of the YES/ENTER key, the assignment completes, the home screen opens and playback starts.

You cannot assign the same virtual track to multiple physical tracks.

If you have not worked with a system using virtual tracks before, you may find it a little confusing. Some ideas to bear in mind:

- If you are recording a difficult part, you do not have to re-record over the top of “almost, but not quite perfect” takes. Keep these for later, just in case you never get a better take. Simply assign a different virtual track when you record the next take.
- For example, suppose you have recorded the drum part and three takes of the bass line. You can assign the three

virtual tracks that contain the bass takes to three physical tracks and then use the faders and **MUTE/SOLO** keys to listen to each of them in turn (for simplicity, these illustrations show only the first eight tracks).

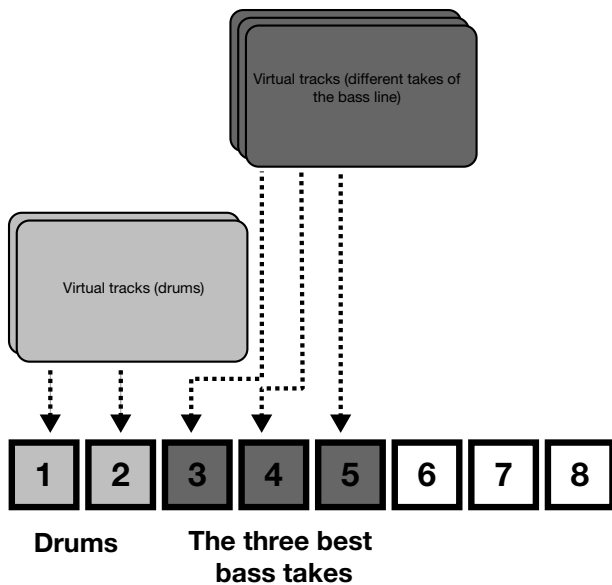

Then pick the one that fits best, and you can re-use the other two unused virtual tracks with new virtual tracks—keep the alternative takes for the future if you change your mind later on.

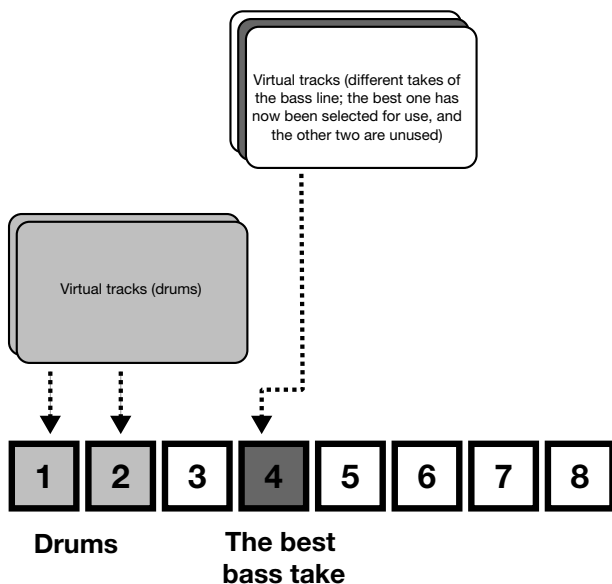

Alternatively, if you want to assemble a track for the whole song, you could assign the three different takes of the part to three different active tracks and use the track editing functions to copy and paste the good parts of each track to make a perfect whole. Then use the two non-perfect tracks with other virtual tracks for new parts.

In this case, you can also reassign the physical tracks of unused virtual tracks to other virtual tracks.

NOTE

Of course, virtual tracks take up disk space, even when you are not using them. If you really do not need a virtual track, you should clean it out to save disk space (see "CLEAN OUT" on page 63).

7 – Recorder

Varispeed operations (pitch and SSA)

You can play back and record at speeds which are greater or less than the original ($\pm 6\%$) to allow for differences in tuning, etc.

It is also possible to play back a selected pair of tracks at the same pitch, but slower than the original (the SSA—Slow Speed Audition feature). This allows you to rehearse tricky lead lines, etc. at a slower speed, and can be combined with repeat playback (“Repeat” on page 55) for easy rehearsals.

NOTE

The monitoring status of the tracks played back using the pitch (varispeed) or SAA features is exactly the same as for normal playback. That is, if they have been assigned to a channel, the volume, etc. is controlled by the channel fader and controls.

Pitch

- 1 Press and hold the PITCH/SSA key.

The indicator lights and the display changes:

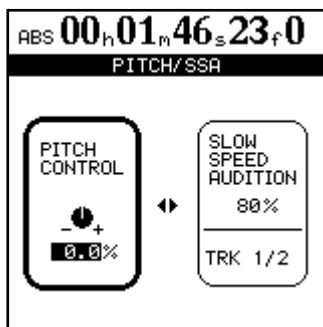

- 2 If the PITCH CONTROL section at the left of the screen is not active (it is not surrounded by the thicker frame), press the ◀ key to move the cursor there.

- 3 Use the dial to change the pitch from -6.0% to $+6.0\%$ in 0.1% steps. If playback is being carried out while this is done, you will be able to hear the change.
- 4 Press the PITCH/SSA key to return to the home screen and once again to turn off the pitch change.

NOTE

The above steps can be carried out while playback is stopped or in operation, but cannot be carried out during recording. It is also possible to start playback while adjusting the pitch, but not to start recording at that time.

To use the set pitch When the pitch change value has been set in the way described above, and the 2488MKII shows the home screen, simply press the PITCH/SSA key briefly to turn the indicator on and to change the pitch.

Press the PITCH/SSA key briefly once again to turn off the pitch change.

SSA (Slow Speed Audition)

- 1 Press and hold the PITCH/SSA key, either during playback, or when the transport is stopped.

The indicator lights and the display changes:

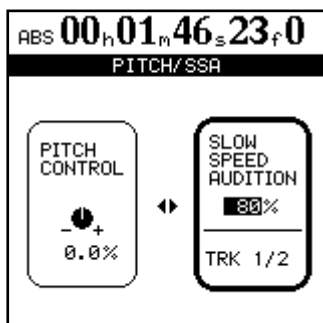

- 2 If the SLOW SPEED section at the right of the screen is not active (it is not surrounded by the thicker frame), press the ▶ key to move the cursor there.
- 3 Use the channel SELECT keys to select the tracks which will be played back. These tracks are always in pairs.

- 4 Use the dial to change the speed between 50%, 60%, 70%, 80%, 90% and 100% (the displayed values are approximate). If playback is being carried out while this is done, you will be able to hear the change.

NOTE

The above steps can be carried out while playback is stopped or in operation, but cannot be carried out during recording. It is also possible to start playback while adjusting the speed, but not to start recording at that time.

- 5 Press the PITCH/SSA key to return to the home screen and once again to turn off the SSA mode.

To use the SSA When the speed change value has been set in the way described above, simply press the PITCH/SSA key briefly to turn the indicator on and to change the speed, but without changing the screen display.

Press the PITCH/SSA key briefly once again to turn off the speed change.

8 – Mastering and CD recorder

Mixdown is the mixing of the audio from every track in a recording into a stereo pair. On the 2488MKII, writing this mixdown signal to a master stereo recorder is called "mastering."

You can make an audio CD using the CD-R/CD-RW recorder built into the 2488MKII.

However, before mastering (burning) a CD, the stereo mix must first be recorded to an internal stereo master track.

You can also send your mixdown signal directly to the **STEREO OUTPUT** jacks to record your song on an attached MD, DAT, cassette or other recording device.

In this case, you do not need to conduct pre-mastering.

NOTE

These operations all deal with songs on the currently-selected partition. If the song you want is on another partition, you must select that disk partition as the active partition before proceeding (see "Selecting the active partition" on page 13).

The procedures for burning a CD using the internal CD-R/CD-RW recorder after recording the stereo mix to an internal stereo master track are explained below.

Pre-mastering

As previously mentioned, before burning a CD, the stereo mix signal must first be recorded to an internal master track.

The start of the pre-mastered material is always the 00:00:00:00 point, and the end of the pre-mastered material is the OUT point.

Before starting the pre-mastering process, make sure that if you are using the sub-mixer, it is assigned to the stereo bus.

The modes related to pre-mastering include the "pre-mastering mode" for recording the master track and the "master check mode" for checking the recorded master track. Press the **MASTER** key to cycle through normal, pre-mastering, and master check modes.

1 Set the OUT point at the end of the material that you intend to pre-master.

2 Press the MASTER key to enter pre-mastering mode (PreMastering appears at the upper left of the home screen).

If any REC indicators are on, they are turned off, and they cannot be turned on again while pre-mastering is being carried out.

While pre-mastering, transport controls work in the usual way, except that:

- Playback and fast forward will stop at the OUT point, and the playback position cannot move past this point.
- Auto punch operations are disabled.
- Jog and trim are disabled.
- Pitch control and SSA are disabled.
- Direct location and repeat playback are disabled.
- Recording is carried out as explained below.

Recording the master track

To record the master track, press and hold the **RECORD** key, and then press the **PLAY** key. Both the **PLAY** and the **RECORD** indicators light.

Recording always starts (regardless of the current position) at 00:00:00:00.

The mastering records the effects of all mixer settings and effect settings, etc.

If you stop the recording before the OUT point is reached, the master recording ends there, and the length of the master track is from the 00:00:00:00 point to the point where you stopped the recording

NOTE

The minimum length for a CD track is four seconds. Be sure that all master tracks are at least this long.

The maximum length for a CD track recorded from the 2488MKII is 80 minutes. Master tracks made with the 2488MKII should not exceed this length.

During the mastering operation, all channel operations (EQ, send, fader/pan) can be carried out, either from the 2488MKII's controls, or by means of MIDI commands.

TIP

While you are recording the master, synchronization and the sub-mixer can be used to add synchronized MIDI sound sources to the stereo master mix.

You can set and edit effect parameters and recall effects from the effect libraries in pre-mastering mode.

It is also possible for you to make assignments while mastering, and recall scene memories.

After recording the master track, you can play back the master track to check it

When you have mastered the recording, you can either re-master the recording (simply press and hold the **RECORD** key and press the **PLAY** key again). Therefore, you can record the master track several times and then use **UNDO** to choose one of the earlier recordings. Or proceed to the master check operation.

Exiting pre-mastering mode

Press the **MASTER** key once to enter the master check mode where you can play back and check the master track. Press the **MASTER** key again to return to the home screen.

8 – Mastering and CD recorder

Checking the master

To check the recorded master track, use the master check mode.

After finishing the pre-mastering, press the **MASTER** key to enter master check mode and open the **MASTER CHECK** screen. The **MASTER CHECK** screen shows the song title and the total time.

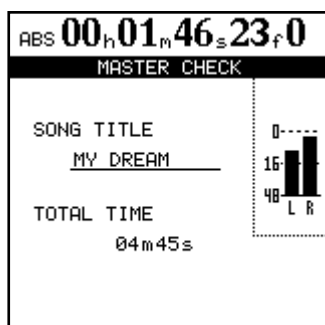

All monitoring is now from the **STEREO** selection only. The master track playback sound is not affected by fader movements or other mixer operations, including new assignments.

No faders or other mixer controls (including assignment) have any effect. The only possible control of the monitor volume is through the **MONITOR LEVEL** controls.

Trimming the master

After creating a master track (or sometimes before), if the recording started too early or ended too late, you can trim the unwanted time.

You cannot trim the master track itself during playback, but since the master track and its source tracks (1–24) use the same timings, by trimming the source tracks, the master track is also trimmed.

Follow these procedures to trim the tracks.

- 1 Confirm that the 2488MKII is in a “normal” mode (not master check or pre-mastering mode).
- 2 Move the playback position to the point that you want to trim (either the start or the end of the master track).

Copying the master track

You can use the **CLONE TRACK** editing function to copy the master track to another track (see “**CLONE TRACK**” on page 63).

The transport controls work in the following way:

- **PLAY** plays back from the current position to the end of the master track.
- **REW** and **F FWD** keys rewind and fast-forward as normal, but the speed does not appear on the screen.
- Press the **STOP** key to stop playback
- Recording is disabled.
- All location functions are disabled.
- Jog, varispeed, SSA, repeat, etc. are disabled.

TIP

*While playing back the master track, it is output from the **STEREO** (and **DIGITAL OUTPUT**) jacks as well as from the **MONITOR** and **PHONES** jacks. Therefore, during pre-mastering or master checking, you can record the stereo mix signal to an external recording device (cassette, digital recorder, MD, etc.).*

Exiting master check mode

Press the **MASTER** key to exit master checking and return to the home screen.

- 3 Set the **IN** and **OUT** points at the beginning (**IN**) and end (**OUT**) of the audio that you want to trim. If you want to trim the start of the master track, set the **IN** point at 00:00:00:00, and the **OUT** point where you want to start the master track. If you want to trim the end of the master track, set the **IN** point where you want to end the master track and the **OUT** point at (or after) the pre-mastering **OUT** point.
- 4 Use the **Track Edit CUT** function to cut all tracks between the **IN** and the **OUT** point. Be sure to select “**ALL**” as the **Src.Trk** value (see “**CUT**” on page 62).
- 5 Play back the master track, as described above. The start and end should now be as you want them.

8 – Mastering and CD recorder

Creating an audio CD

You can create an audio CD by using the 2488MKII CD-RW drive to burn the master track to a CD-R/CD-RW disc. Three audio CD creation methods are available. Track At Once (TAO) burns CD tracks one at a time, while Disc At Once (DAO) burns multiple master tracks as CD tracks at one time. Furthermore, the 2488MKII has a Live Writer function that uses marks to burn one master track as multiple CD tracks.

Remember that whichever method you use to record your CDs, you can record a maximum of 99 tracks on one CD,

the minimum length of a track is four seconds, and the maximum track length you can record from the 2488MKII is 80 minutes.

NOTE

Only one of the above methods can be used in recording a single disc. For example, a disc that has tracks that were recorded using TAO can have another CD track added using TAO, but recording with DAO or Live Writer is not possible. DAO and Live Writer recording is only possible on a blank disc.

Creating an audio CD using TAO

Before starting this operation you must make sure that there is a recordable disc inserted in the CD-RW drive. If there is no recordable disc (that is, a CD-R or CD-RW disc that has not been finalized), the 2488MKII shows an appropriate message.

- 1 Make sure the 2488MKII is in “normal” mode (not master check or pre-mastering mode). On the AUDIO CD menu, move the cursor to CD WRITER and press YES/ENTER.

The 2488MKII checks the disc. After verifying that the disc is recordable, a list of the pre-mastered songs on the current partition appears.

NOTE

If a song has been recorded, but has not been mastered, it will not appear in the list.

If you want to change partitions, see “Selecting the active partition” on page 13.

- 2 Use the JOG/DATA dial to select the song whose master track you want to write to the CD, and press the YES/ENTER key.

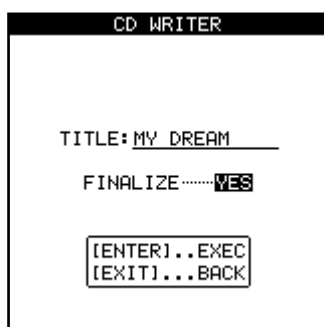

- 3 Choose at this point whether you want to finalize the disc.

If you finalize the disc at this stage, you will not be able to add any more CD tracks to it.

TIP

If you do not finalize the disc at this stage, you can finalize it later in a separate operation.

- 4 Press YES/ENTER to continue, and NO/EXIT if you want to choose a different song.
- 5 You are asked if you are sure that you want to record the song. Press YES/ENTER to proceed with the recording. CD writing begins. Two seconds of silence are automatically added to the end of each track recorded to disc.

NOTE

A pop-up message appears if there is not enough space on the disc to write a CD track. In this case, you can adjust the length of the master track (see “Trimming the master” on page 70) or use a different disc.

All other 2488MKII functions are disabled during CD writing.

CAUTION

DO NOT TURN OFF the 2488MKII while this writing operation is taking place. You will almost certainly spoil the disc and may corrupt the song data.

Do not press the eject button below the disc tray while a disc is being written. Doing so may cause the disc writing procedure to fail.

- 6 To check the recorded disc, use the CD PLAYER option described below.

8 – Mastering and CD recorder

Finalizing the disc

When you have recorded the last CD track on a disc, you must finalize it to make it playable on ordinary CD players. Before finalizing, you can check the recorded CD tracks using the 2488MKII's CD PLAYER function.

The CD-RW drive must contain an unfinalized disc before you start the process.

- 1 Make sure the 2488MKII is in “normal” mode (not master check or pre-mastering mode). On the AUDIO CD menu, move the cursor to FINALIZE and press YES/ENTER.

- 2 A pop-up screen asks if you are sure. Press YES/ENTER to continue, NO/EXIT to stop the finalize process.

If you continue, the CD session is closed and the finalizing material (Table of Contents or TOC) is written to the disc.

NOTE

You cannot add CD tracks to a finalized disc. You can only finalize a disc once, and you cannot unfinalize a disc.

During finalizing, the CD-RW drive's eject button cannot be used.

Creating an audio CD using DAO

When recording multiple CD tracks at once, you can set the order in which the tracks are recorded.

Once a CD has been made in this way, no further tracks can be added, as the CD is automatically finalized at the end of the operation.

- 1 Insert a blank CD-R/CD-RW disc in the CD- RW drive before starting the following procedures.
- 2 With the 2488MKII stopped in a “normal” mode (not master check or pre-mastering mode), choose CD WRITER from the AUDIO CD menu, and press the YES/ENTER key.

The 2488MKII checks the disc. After verifying that the disc is recordable, a list of the pre-mastered songs on the current partition appears on screen.

NOTE

If a song has been recorded, but has not been mastered, it will not appear in the list.

If you have a song in another partition which you want to add to the list in the current partition, you should copy it from the old partition to the current partition (see “Copying songs” on page 46).

- 3 Use the dial to scroll through the list of songs, and when you highlight a song that you wish to add to the final CD, press the INSERT key.

A check mark appears by the title of every selected song. There is no need to worry about the final running order of the CD at this stage.

CD WRITER	
SONG	TIME
✓FIRE	03:12
✓ROCK'N ROLL	04:31
✓WALTZ FOR...	03:23
↑ TRILOGY	06:15
● MY DREAM	03:58
↓ REVOLUTION	05:26
SOMEDAY MY..	04:52
✓LOOKING FOR	04:31
HURRICANE	04:24
TOTAL SONG : 4	
TOTAL TIME : 18m04s	

- 4 If you have made a mistake in adding a song to the list, you can remove it by highlighting the title and pressing the DELETE key.

- 5 When you have added all the songs to the list that you want to record on the CD, press YES/ENTER.

NOTE

If you have only selected one song, the procedure from now is as if you had highlighted the song and pressed YES/ENTER, as described above. Read that section, and ignore the remainder of this section.

The screen changes to the song order screen (if you want to return to the song selection screen, press NO/EXIT).

CD WRITER	
SONG ORDER	TIME
↑ FIRE	03:12
● WALTZ FOR...	03:23
↓ MY DREAM	03:58
LOOKING FOR	04:31
TOTAL SONG : 4	
TOTAL TIME : 18m04s	

- 6 Use the dial to scroll through the list of songs.
- 7 When a song title is highlighted, use the ▲ and ▼ keys to move it up and down in the list. As the song is moved up and down in the list it remains highlighted. Select further songs for rearrangement using the dial.
- 8 Repeat procedures 6 and 7 as necessary.
- 9 When you have completed the running order, press YES/ENTER.

The screen changes to the “gap setting” screen. This allows you to set the gap between tracks on the CD (press NO/EXIT to return to the song order screen).

8 – Mastering and CD recorder

CD WRITER	
SONG	GAP
FIRE	0.0 sec
WALTZ FOR...	0.0 sec
MY DREAM	0.0 sec
LOOKING FOR	1.0 sec

TOTAL SONG : 4
TOTAL TIME : 18m05s

- 10 Use the ▲ and ▼ keys to move the cursor to the gaps between the songs on the CD.
- 11 Use the dial to set the time in seconds between songs, from 0.0 seconds (no gap) through 9.9 seconds in 0.1 second steps.

NOTE

When you come to play back the disc on a CD player, the start of the gap will appear as Index 0 on the track following the gap, and the start of the track will appear as Index 1. Because the gap counts as a part of the track, the total length of the track and gap together cannot exceed 80 minutes.

- 12 When all the gaps have been set, press YES/ENTER. A pop-up asks if you are sure. Use the YES/ENTER key to proceed with writing the CD or the NO/EXIT key to cancel the operation.
- 13 When you press YES/ENTER, a disk image is made of each song in turn, which is then written to the CD. CD writing begins.

The disc is finalized after writing is finished.

CAUTION

DO NOT TURN OFF the 2488MKII while this writing operation is taking place. You will almost certainly spoil the disc and may corrupt the song data.

NOTE

During writing the CD-RW drive's eject button does not operate. You can only eject the disc after writing has finished.

If you use a CD-RW disc, it may not be playable in audio CD players that are not designed to handle CD-RW discs

Creating an audio CD using Live Writer

When you want to make a CD of multiple pieces that have been recorded continuously, for example, a live performance recorded without break, the 2488MKII allows you to split a single song into several CD tracks. In this kind of situation, the Live Writer function uses the marks placed in a song to split a master track into CD tracks when writing a disc.

NOTE

With this function, the disc is automatically finalized and you cannot add further tracks to the CD after it has been made.

To make a CD from the currently loaded song using the Live Writer function:

- 1 Insert marks into a song with a recorded master track at the points where the CD track splits are to occur.
 - Track lengths must be at least 4 seconds, so there must be at least 4 seconds between marks.
 - You can insert up to 98 marks (allowing up to 99 tracks).
- 2 With the 2488MKII stopped, select LIVE WRITER from the AUDIO CD menu, and press the YES/ENTER key. The disc tray opens.

- 3 Insert a blank CD-R/CD-RW disc, and press the YES/ENTER key. The LIVE WRITER screen opens and shows a list of CD track times calculated from the marks inserted in the current song.

LIVE WRITER	
MARK	TIME
Mark 001	03:12
ROCK'N ROLL	04:31
WALTZ FOR...	03:23
↑ TRILOGY	06:15
⊙ DREAMS	03:58
↓ REVOLUTION	05:26
SOMEDAY MY..	04:52
LOOKING FOR	04:31
HURRICANE	04:24

TOTAL MARK : 9
TOTAL TIME : 40m32s

- 4 Press the YES/ENTER key unless there is a problem with this list. A confirmation message appears.
- 5 Press the YES/ENTER key again to start making the CD. When the CD is complete, the tray automatically opens, and a message appears asking if you want to make another copy of the CD.
- 6 If you do want to make another copy, insert a blank CD-R/CD-RW disc and press the YES/ENTER key. If you do not want to make another CD, press the NO/EXIT key.

8 – Mastering and CD recorder

Playing CDs

If an audio CD (either finalized or unfinalized) is inserted into the 2488MKII's CD-RW drive, the 2488MKII can play it back.

The sound is output through the **MONITOR** and **PHONES** jacks. The only control over the sound from the 2488MKII is through the **MONITOR** control knob. All other mixer controls are disabled.

- 1 **Make sure the 2488MKII is in “normal” mode (not master check or pre-mastering mode). On the AUDIO CD menu, move the cursor to CD PLAYER and press YES/ENTER.**

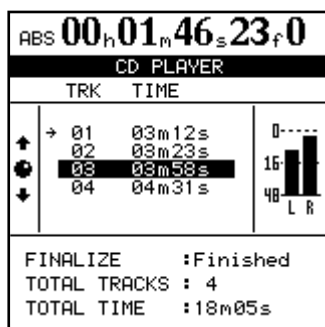

The screen shows:

- Whether the disc is finalized or not
- The number of tracks and the total running time of the disc.
- CD track lists and CD track times
- The current CD track (indicated by an arrow)
- The stereo meters also show the level of the audio recorded on the disc

CD-RW erase

To erase a CD-RW disc created on the 2488MKII, you must use this function. You cannot erase such a disc on any other equipment.

Also note that you must erase the whole disc. You cannot erase individual data files (or songs on an audio disc). This operation cannot be undone. Once the data is erased from the disc it cannot be recovered from the disc. Make sure you have copies of any data you might want in the future.

- 1 **Insert the CD-RW disc to be erased into the drive (use the drive eject key or the tray open/close function described below to do this).**

CD EJECT

You should use this function to open the disc drive tray. It is important that you do not press the CD-RW drive eject button while the drive is operational. If you do, it may cause problems in the operation of the 2488MKII. We therefore recommend that you always use this CD EJECT menu item to eject discs.

The 2488MKII transport controls are used to control playback of the CD, as explained here:

- **PLAY** starts playback from the current playback position. When searching for a CD track, the PLAY indicator flashes.
- **STOP** stops playback at the current position
- **REW** and **F FWD** select CD tracks when stopped.
- **JOG/DATA** dial selects CD tracks when stopped.

All other playback functions are disabled

NOTE

While this screen is displayed (the CD Player function is active), the eject button on the CD-RW drive is disabled. To eject the CD, press EXIT to exit the CD player function, and the CD is then ejected.

- 2 **With the transport stopped, from the DISK menu, highlight CD-RW ERASE, and press YES/ENTER. A pop-up confirmation message appears. Press YES/ENTER to erase the disc.**
Alternatively, press NO/EXIT to cancel the operation.
- 3 **After the disc has been erased, the drive tray opens automatically.**

- 1 **With the transport stopped, from the DISK menu, highlight CD EJECT, and press YES/ENTER.**

- 2 **The tray opens and a pop-up appears. Remove or change or insert the disc.**

You can also open the disc drive by pushing the eject button.

9 – Reformatting

As noted in the section on “Basic Knowledge” (page 13), the 2488MKII hard disk is divided into a FAT-32 partition for audio file exchange, and multiple TASCAM partitions.

You can reformat the entire hard disk or individual partitions.

CAUTION

Reformatting erases all the data on the disk or partition and it cannot be undone. Back up all the songs and data that you want to save, using CD-R/CD-RW

discs or a computer’s hard drive, before starting this operation (see “Backup and restoration” on page 83).

Do not turn off the power during formatting. This may lead to the loss of recorded data and/or not being able to restart the 2488MKII.

Reformatting the entire hard disk

You can change the size of the TASCAM partitions when you reformat the hard disk. All partitions are created with the same size, which may be 4, 8, 16 or 32 gigabytes*. A maximum of four partitions may be allocated.

Note that it is possible to allocate four smaller partitions, and therefore leave part of the hard disk space unused. TASCAM native partitions cannot be accessed from a host computer using USB.

The FAT partition size is always fixed at 8GB.

* A gigabyte is defined here as 1024 megabytes. A gigabyte holds just under four hours’ worth of 16-bit mono audio.

- 1 With the transport stopped, press MENU key.
The MENU screen appears.
- 2 Highlight DISK and press YES/ENTER. Then the DISK menu appears.
- 3 Highlight FORMAT and press YES/ENTER.

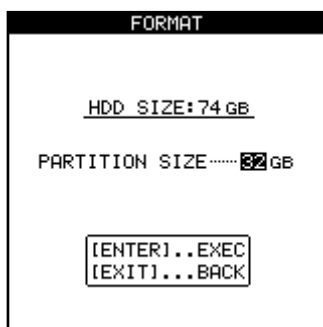

The hard disk size is shown at the top of the screen, and the partition size is shown below this.

- 4 Use the dial to change the partition size.
- 5 Press YES/ENTER to continue with the format operation. Press NO/EXIT to halt the operation.

If you continue with the format, a pop-up message appears to ask you once again whether you are really sure you want to format the disk.

- 6 Press YES/ENTER to continue with the format, and NO/EXIT to stop the process.

CAUTION

While the format operation is taking place, the HD indicator lights and you cannot perform any operations. Make sure that you do not turn off the 2488MKII during the format operation. If the 2488MKII is turned off during formatting, you may not be able to restart the unit afterwards.

- 7 When the format operation is complete, a new blank song is automatically created on each partition.

9 – Reformatting

Reformatting TASCAM partitions

In addition to formatting the entire hard disk as described above, you can also format individual TASCAM partitions.

CAUTION

When you perform this operation, all data on the selected partition is destroyed. This operation cannot be undone. Before performing this operation, make sure that all songs and data that you want to keep are backed up, either to disc or to a personal computer (see "Backup and restoration" on page 83).

- 1 With the transport stopped, from the DISK menu, highlight REFORM, and press YES/ENTER.
- 2 Use the dial to select the partition to be reformatted, Press YES/ENTER.
A pop-up message appears.
- 3 Ask yourself once more if you want to format the partition and erase all the data on it. Press YES/ENTER to continue with the format operation. Press NO/EXIT to halt the operation.

REFORM	
PARTITION	SIZE
Part01	32768 MB
Part02	32768 MB
Part03	2583 MB

CAUTION

While the format operation is taking place, the HD indicator lights and you cannot perform any operations. Make sure that you do not turn off the 2488MKII during the format operation.

- 4 When the format operation is complete, a new blank song is automatically created on the partition.

Reformatting the FAT partition

If you run out of free space on the FAT partition, use the following procedures to delete all the data on it, and reformat it.

CAUTION

Do not attempt to format the FAT partition using a computer. Use only this procedure to perform the operation.

Note that it is not possible to erase individual files from the FAT partition using the 2488MKII alone. To do that, you must connect the 2488MKII to a computer, and treat the FAT partition as a computer hard disk.

- 1 With the transport stopped, from the DISK menu, highlight FAT REFORM, and press YES/ENTER.
- 2 A pop-up message appears.
- 3 Ask yourself once more if you want to erase all the data on the FAT partition. Press YES/ENTER to continue with the operation when a pop-up appears, or press NO/EXIT to halt the operation.

- 4 When you reformat the FAT partition, four directories (folders) named WAVE, SMF, BACKUP and UTILITY are automatically created. These folders are used for audio files, Standard MIDI Files (SMF) and backup data and system utilities, respectively.

CAUTION

When you perform this operation, all existing data on the FAT partition is destroyed. This operation cannot be undone. Before performing this operation, make sure that all data on the FAT that you want to keep are backed up to a personal computer (see "Backup and restoration" on page 83).

10 – File import/export

See “Use with a personal computer” on page 8 for conditions regarding the connection of a computer.

The 2488MKII can import and export the following file types.

WAV files

When the 2488MKII imports a WAV file, the file is first stored on the FAT partition before you import it to a virtual track. Imported files must have a sampling frequency of 44.1 kHz, and a bit depth of 16 or 24 bits.

Note that if you are importing a 16-bit audio file for use in a 24-bit song, you will only enjoy 16 bits of resolution in the

imported audio—the 2488MKII cannot magically recreate the extra eight bits. And if you import a 24-bit audio file into a 16-bit song, the bottom eight bits will be truncated.

SMF

When the 2488MKII imports an SMF file, the file is first passed through the FAT partition before being imported into a song. The 2488MKII outputs MIDI messages based on the SMF.

USB mode

To transfer files and back up and restore data between the 2488MKII and a computer, connect them with a USB cable and open the 2488MKII's USB mode. When these operations are finished, close the USB connection and disconnect the USB cable.

Opening the USB connection

- 1 **Connect the 2488MKII and the computer with a USB cable.**
Use a cable designed for USB 2.0 to assure fast and accurate data transfer.
- 2 **With the transport stopped, press the MENU key to open the MENU screen.**
- 3 **Select DISK, and press the YES/ENTER key to open the DISK menu.**
- 4 **Select USB OPEN/CLOSE, and press the YES/ENTER**

key. When the confirmation pop-up screen opens, press YES/ENTER again.

The 2488MKII saves unsaved data and then a pop-up screen saying, USB OPEN appears.

- 5 **While the pop-up screen is visible on the 2488MKII, the 2488MKII should be recognized as a “removable disc” by the connected computer. While connected in this way, all the 2488MKII controls are disabled.**

Closing the USB connection

- 1 **Close the USB connection from the computer.**

Windows 2000 or Windows XP

A PC card and arrow icon appears in the system tray (normally at the bottom right of the screen). Left click this icon to open a pop-up bar.

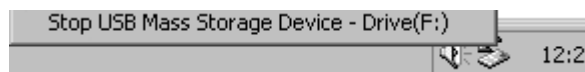

To close the connection between the 2488MKII and the computer, click this pop-up bar, and when a message telling you it is safe to disconnect the 24800MKII appears on the computer screen, remove the USB cable. If a message appears on the computer screen telling you that it is not safe to disconnect the 2488MKII, exit all programs on the computer that may be accessing files on the 2488MKII, and try again.

Macintosh OS 9 or OS X

Drag the 2488MKII's disk icon to the Trash or type “Command+E” to disconnect (in OS X10.3 and above, you can also use the eject button for removable media in the Finder). When the 2488MKII hard disk icon disappears from the desktop, remove the USB cable.

TIP

If you have changed the settings for the Mac OS Finder, the 2488MKII hard disk icon may not appear on the desktop, but it should appear in a top-level Finder window.

- 2 **To close the USB connection on the 2488MKII, press and hold the NO/EXIT key on the 2488MKII. A confirmation message appears**
- 3 **Press the YES/ENTER key to close the USB connection.**

CAUTION

Do not remove the USB cable while data is being transferred between the 2488MKII and the computer. Follow the procedures above first to remove the cable safely.

10 – File import/export

USB import (mono WAV files)

When importing mono WAV files from a computer, they are first stored on the FAT partition (see “Hard disk and partitions” on page 13).

- 1 With the transport stopped, connect the 2488MKII and a computer using USB (see “Opening the USB connection” on page 77).
- 2 Drag and drop mono WAV files from your computer’s disk to the WAVE folder on the 2488MKII’s FAT partition.
- 3 Disconnect the 2488MKII and the computer (see “Closing the USB connection” on page 77).

Use the following procedures to copy files from the FAT partition to virtual tracks.

- 4 With the transport stopped, press MENU. The MENU screen appears.
- 5 Select the WAVE IN/OUT and press YES/ENTER. The WAVE IN/OUT menu screen appears.
- 6 Select the USB IMPORT and press YES/ENTER.

USB IMPORT	
WAVE FILE	SIZE
KICK.WAV	32MB
SNARE.WAV	43MB
BASS.WAV	45MB
TOM.WAV	51MB
GUITAR1.WAV	42MB
HAT.WAV	40MB
CYMBALS.WAV	49MB
AMBIENCE.WAV	10MB

FAT -> PARTITION 01
FREE AREA : 5821MB
SONG TITLE:MY DREAM

- 7 Use the dial (or the cursors) to select the wave file that you want to use. Press YES/ENTER.

V. TRACK	
TRACK001	
TRACK005	
TRACK007	
TRACK008	
TRACK009	
TRACK010	
TRACK012	
TRACK014	
TRACK016	

Select V.track to which wave file assign.

- 8 Now you can select the virtual track to which the wave file will be copied. Press YES/ENTER.

A confirmation pop-up message appears.

Press the YES/ENTER key again to copy the WAV file to the virtual track.

- 9 To use the imported WAV file, assign the virtual track containing the file to a physical track (see “Virtual tracks” on page 66).
- 10 Repeat procedures 7 to 9 as necessary.

USB import (stereo WAV files)

When importing stereo WAV files from a computer, they pass through the FAT partition (see “Hard disk and partitions” on page 13).

- 1 With the transport stopped, connect the 2488MKII and a computer by USB (see “Opening the USB connection” on page 77).
- 2 Drag and drop stereo wave files from your computer’s disk to the WAVE folder on the 2488MKII FAT partition.
- 3 Disconnect the 2488MKII and the computer (see “Closing the USB connection” on page 77).

Follow the procedures below to copy a file from the FAT partition to a virtual track pair assigned to a physical track pair.

- 4 With the transport stopped, press MENU. The MENU screen appears.
- 5 Select the WAVE IN/OUT and press YES/ENTER. The WAVE IN/OUT menu screen appears.

- 6 Select ST.WAV IMPORT, and press the YES/ENTER key to open the ST.WAV IMPORT screen.
- 7 Use the dial (or the cursors) to select the wave file that you want to use. Press YES/ENTER.

ST.WAV IMPORT	
WAVE FILE	SIZE
ROCK.WAV	43MB
WALTZ.WAV	45MB
TRILOGY.WAV	51MB
MY_DREAM.WAV	42MB
TANGO.WAV	40MB
SOMEDAY.WAV	49MB
DREAMS.WAV	32MB

FAT -> PARTITION 01
FREE AREA : 5821MB
SONG TITLE:MY DREAM

- 8 Now you can select the physical track pairs to which the wave file will be copied. Press YES/ENTER.

You can choose from mono track pairs 1/2–11/12 for stereo track 13/14–23/24 for physical track pair.

USB import (SMF files)

You can also import Standard MIDI Files through the USB connection. For full details on how to use SMF files, see “SMF playback” on page 90.

- 1 With the transport stopped, connect the 2488MKII and a computer by USB (see “Opening the USB connection” on page 77).

- 2 Drag and drop SMF from your computer’s disk to the SMF folder on the 2488MKII FAT partition.

You can drag and drop multiple files.

- 3 Disconnect the 2488MKII and the computer (see “Closing the USB connection” on page 77).

Follow the procedures below to load a file from the FAT partition to the 2488MKII’s SMF player.

- 4 With the transport stopped, press MENU.

The MENU screen appears.

- 5 Select the SYNC/MIDI and press YES/ENTER. The SYNC/MIDI menu screen appears.

- 6 When SMF PLAYER appears in inverse, press the YES/ENTER key to open the SMF PLAYER screen.

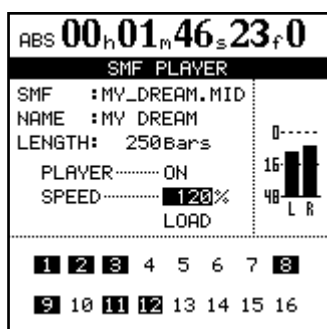

- 7 Use the cursors to select LOAD, then press YES/ENTER.

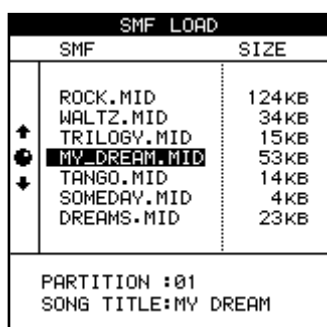

- 8 Move the cursors to the file you want to load, and press YES/ENTER.

NOTE

Note that there is no SMF export function (the 2488MKII cannot create or edit MIDI sequences).

10 – File import/export

USB export (virtual tracks)

This is basically the reverse of the import procedure. First, select a virtual track and then export its contents to the FAT partition before connecting the 2488MKII to the computer and copying the file.

- 1 With the transport stopped, press MENU to open the MENU screen.
- 2 Select the WAVE IN/OUT and press YES/ENTER. The WAVE IN/OUT menu screen appears.
- 3 When USB EXPORT appears in inverse, press the YES/ENTER.

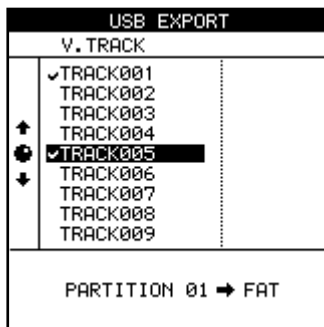

A list of virtual tracks with recorded audio data appears.

- 4 Use the JOG/DATA dial (or ▲/▼ cursor keys) to select the virtual track for export, and press the INSERT key to put a check mark next to its name. You can export many virtual tracks at the same time by checking multiple virtual tracks for export. If you accidentally place a check mark next to a virtual track that you do not want to export, press the DELETE key to remove the check mark.
- 5 After selecting the virtual tracks for export, press the YES/ENTER key

A pop-up message appears.



- 6 Select the final bit depth (RESOLUTION) of the exported files (16 or 24 bits). The file size of the exported data changes according to the bit depth.

- 7 Press the YES/ENTER key.

The audio data on the virtual track is converted to a WAV file and copied to the FAT partition.

Press the NO/EXIT key to cancel export.

- 8 With the transport stopped, connect the 2488MKII and a computer using USB (see “Opening the USB connection” on page 77).
- 9 Use the computer to copy the files from the 2488MKII to the computer's hard disk.
- 10 Disconnect the 2488MKII and the computer (see “Closing the USB connection” on page 77).

Exporting master tracks

You can export one or more master tracks to a computer. The master tracks must all reside on the same TASCAM partition. Master tracks are converted to stereo WAV files, and sent to the FAT partition, from where they can be copied to the computer. Regardless of the master track bit depth, the exported stereo WAV file is 16-bit.

- 1 With the transport stopped, press the MENU key to open the MENU screen.
- 2 Use the JOG/DATA dial (or ▲/▼ cursor keys) to select WAVE IN/OUT, and press the YES/ENTER key to open the WAVE IN/OUT menu.
- 3 When MASTER EXPORT is highlighted, press the YES/ENTER key to view a list of songs with recorded master track.

MASTER EXPORT	
SONG	SIZE
✓FIRE	322MB
✓ROCK'N ROLL	430MB
✓WALTZ FOR...	459MB
↑ TRILOGY	510MB
● MY DREAM	422MB
↓ REVOLUTION	403MB
✓SOMEDAY MY..	495MB
✓LOOKING FOR	5MB
HURRICANE	1MB

PARTITION 01 → FAT
FREE AREA: 995MB

- 4 Use the JOG/DATA dial (or ▲/▼ cursor keys) to select a master track for export and press the INSERT key to put a check mark by the master track. You can convert many master tracks into stereo WAV files and send them to the FAT partition at the same time by checking all the master tracks that you want to export.

Use the DELETE key to remove a check mark.

- 5 Press the YES/ENTER key.

A confirmation screen appears.

- 6 Press the YES/ENTER key again to convert the master track into a stereo WAV file and send it to the FAT partition.

When the operation is completed, the home screen appears.

To cancel transfer to the FAT partition, press the NO/EXIT key instead of the YES/ENTER key.

- 7 With the transport stopped, connect the 2488MKII and the computer using USB (see “Opening the USB connection” on page 77.)
- 8 Use the computer to copy the WAV file(s) from the 2488MKII to the computer.
- 9 Disconnect the 2488MKII and the computer (see “Closing the USB connection” on page 77.)

Importing from CD (mono WAV files)

The 2488MKII can only read mono WAV format files from the top-level directory (root) of a data disc with no other files on the disc. Files in subdirectories cannot be imported.

When these files are imported, they are copied to virtual tracks, which must then be assigned to physical tracks to be used.

- 1 Insert the disc containing the files into the CD-RW drive.
- 2 With the transport stopped, press the MENU key to open the MENU screen.
- 3 When WAVE IN/OUT appears in inverse, press the YES/ENTER key to open the WAVE IN/OUT menu.
- 4 Select CD IMPORT and press YES/ENTER.

CD IMPORT	
WAVE FILE	SIZE
KICK.WAV	32MB
SNARE.WAV	43MB
BASS.WAV	45MB
TOM.WAV	51MB
● GUITAR1.WAV	42MB
HAT.WAV	40MB
CYMBALS.WAV	49MB
AMBIENCE.WAV	10MB

FAT → PARTITION 01
FREE AREA : 5821MB
SONG TITLE:MY DREAM

- 5 Use the dial (or the cursors) to select the wave file to be imported, and press YES/ENTER.

CD IMPORT	
V. TRACK	
TRACK001	
TRACK005	
TRACK007	
↑ TRACK008	
● TRACK009	
↓ TRACK010	
TRACK012	
TRACK014	
TRACK016	

Select V.track
to which
wave file assign.

- 6 Select the destination virtual track for WAV file import, and press the YES/ENTER key. A confirmation message appears.
- 7 Press the YES/ENTER key again to copy the WAV file to the virtual track.

To cancel file import, press the NO/EXIT key instead of the YES/ENTER key.

10 – File import/export

Exporting to CD (virtual tracks)

You can convert virtual tracks to WAV files and export them to a CD-R/CD-RW disc.

Even if the song is recorded at 24-bit resolution, you can export 16-bit WAV files.

- 1 Insert a blank CD-R or CD-RW into the CD-RW drive.
- 2 With the transport stopped, press the MENU key to open the MENU screen.
- 3 When WAVE IN/OUT appears in inverse, press the YES/ENTER key to open the WAVE IN/OUT menu.
- 4 Select CD EXPORT and press YES/ENTER.

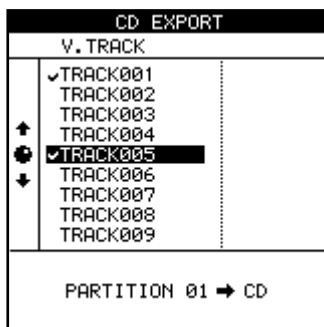

A list of virtual tracks with recorded audio data appears.

- 5 Use the JOG/DATA dial (or ▲/▼ cursor keys) to select a virtual track for export and press the INSERT key to put a check mark next to the track name. You can export many virtual tracks at the same time by adding check marks by multiple tracks. If you accidentally place a check mark next to a virtual track that you do not want to export, press the DELETE key to remove the check mark.
- 6 After selecting all the virtual tracks that you want to export, press the YES/ENTER key.

A pop-up message appears.



- 7 Select the final bit depth (**RESOLUTION**) of the exported files (16 or 24 bits). The file size of the exported data changes according to the bit depth.
- 8 Press YES/ENTER to copy the virtual tracks to the disc.

To cancel the export, press NO/EXIT.

11 – Backup and restoration

Backup

You can use the 2488MKII's CD-RW drive to back up your work to disc. You can either use CD-R media (cheaper, but you can only use it once) or CD-RW media (slightly more expensive, but you can erase and reuse it many times).

NOTE

The operations all deal with songs on the currently-selected partition. If the song you want is on another partition, you must select another disk partition as the active partition before proceeding (see "Selecting the active partition" on page 13).

A disc that you make in this way is not an audio CD—you cannot play it on a CD player, and it can be read only by a 2488MKII.

NOTE

Observe the usual precautions when working with recordable media: handle discs by their edges, avoid getting fingerprints or grease on the recording surface, and keep them clean. Also, avoid using hard pens or pencils or oil-based markers to label the discs.

- 1 Insert a blank CD-R or CD-RW disc in the disc drive.
- 2 With the transport stopped, press the MENU key and select DATA BACKUP, then press YSE/ENTER. The DATA BACKUP menu appears.
- 3 Select CD BACKUP and press YSE/ENTER.

CD BACKUP	
SONG	SIZE
SONG001	322MB
SONG002	430MB
SONG003	459MB
↑ SONG004	510MB
● SONG005	422MB
↓ SONG006	403MB
SONG007	495MB
SONG008	5MB
SONG009	1MB

PARTITION 01 → CD
FREE AREA: 700MB

- 5 Select your song using the dial (or the cursors) and press YES/ENTER. A pop-up message appears telling you how many discs will be needed to back up the song.
- 6 Press YES/ENTER again. A pop-up message tells you the progress of the backup operation.
A backup may span more than one disc.
- 7 When the backup is complete or if the first disc is full, the disc drive tray opens. Remove the disc, label it and store it in a safe place.

- 8 Continue the process if more discs are needed until the backup is complete.

NOTE

If you are backing up to more than one disc, you must ensure that the discs are identical (from the same manufacturer). Even if two discs from different manufacturers have the same stated capacity, you may not be able to use them in the same backup operation.

CAUTION

Never turn off the 2488MKII's power when data is being written to disc. If the power is turned off in the middle of a backup, the loaded disc may become unusable and song data could be damaged.

Do not press the disc tray eject button when data is being written to disc as this may cause the operation to fail.

11 – Backup and restoration

Restoring from CD

If you ever need to restore your data from a data backup CD or CDs, you basically reverse the process.

Before you start restoring a song, make sure that you have all the discs that were used to back up the song.

If some of the discs are missing, you will not be able to restore the song (you cannot load half a song).

- 1 Put the first (or only, if there is only one) disc of the backup set into the CD-RW drive.
- 2 With the transport stopped, press the MENU key. From the DATA BACKUP menu, select CD RESTORE. The 2488MKII reads the title of the song from the disc and asks you if you want to continue.

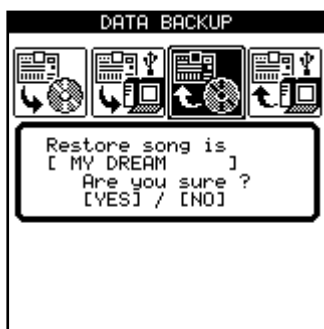

- 3 Press YES/ENTER to continue, NO/EXIT to eject the disc and cancel the operation.
- 4 If you go ahead with the restore, the 2488MKII copies the data from the disc to the active disk partition. A bar graph on screen shows the progress.
- 5 If the backup is spanning more than one disc, when the first disc has been read, it is ejected, and a message asks you to put in the next disc. Insert the next disc and press YES/ENTER.

To cancel restoration, press the NO/EXIT key instead of the YES/ENTER key. You cannot cancel a restoration once it has started.

If you insert the wrong disc (out of sequence or from a different backup set), the 2488MKII ejects the “bad” disc and asks you again for the correct one. If you really cannot find the right disc, you must press NO/EXIT to cancel the restore.

NOTE

If you cancel the restore operation part of the way through, none of the song is restored, and the 2488MKII goes back to the state before the restore was started.

- 6 When data is restored from the last disc, the disc is ejected, and the restored song is loaded.

Using USB for backup and restore

By using a USB cable to connect the 2488MKII and a personal computer, it is possible to back up songs and restore them to and from the computer’s disk drive.

Song data that has been backed up this way is not audio data and therefore cannot be played back on a computer.

It is also possible to use the USB connection to import and export audio files. See “File import/export” on page 77 for details.

The 2488MKII and USB data transfer is carried out at USB 2.0 speeds (if your computer uses the older 1.1 USB standard, it will still work, just slower). Consult your computer documentation for details.

NOTE

We recommend that you always use a cable designed for USB 2.0 operations to ensure accurate and fast data transfer.

See “Use with a personal computer” on page 8 for conditions regarding the connection of a computer.

11 – Backup and restoration

Backing up

If you do not understand the 2488MKII's disk arrangement, you should read "Hard disk and partitions" on page 13.

Backup to a computer connected via USB is a two-stage process. The first stage is copying the song data from a TASCAM partition to the FAT partition, and the second stage is copying it from the FAT partition to the computer.

To backup:

- 1 With the transport stopped, press the MENU key. Note that you do not have to connect the 2488MKII to the computer at this stage.

From the DATA BACKUP menu, select USB BACKUP. The screen shows a list of songs on the current partition, and their size.

USB BACKUP	
SONG	SIZE
SONG001	322MB
SONG002	430MB
SONG003	459MB
SONG004	510MB
SONG005	422MB
SONG006	403MB
SONG007	495MB
SONG008	5MB
SONG009	1MB

PARTITION 01 → FAT
FREE AREA: 995MB

- 2 Note the size of the free space available on the FAT partition, and select a song which will fit onto that partition.
- 3 Press YES/ENTER when you've selected the song. The HD indicator flashes as the song data is copied.
 - The song files in the FAT partition will appear as "8.3" filenames, rather than with the 12-character internal names. The "real" longer names are stored as a part of the song.
 - If the data for a single song exceeds 4 GB, the song file backup is split into 2 parts. Make sure these files are kept together.
- 4 When the copy is finished, attach the 2488MKII to your computer using a USB 2.0 cable.
- 5 Select the DISK option and press YES/ENTER and then select the USB OPEN/CLOSE option and press YES/ENTER (see "Opening the USB connection" on page 77). The 2488MKII will appear as a removable disk on your computer system.
- 6 Drag and drop the song file from the 2488MKII to your computer's disk. You can then archive it, burn a backup CD-R, etc. Note that you should not rename it at all—when you come to restore it, the 2488MKII needs the filename in its original state as it came from the 2488MKII.

- 7 Disconnect the 2488MKII and the computer (see "Closing the USB connection" on page 77).

TIP

If you repeat this process many times, you may find that the FAT partition fills up. You can manage the files on the FAT partition from your computer, as well as erasing the FAT partition's contents from the 2488MKII.

11 – Backup and restoration

Restoring

This is basically the reverse of the backup process. The archived song data is copied from the computer onto the 2488MKII's FAT partition and from there onto a TASCAM partition.

- 1 With the transport stopped, connect the 2488MKII and a computer using USB (see “Opening the USB connection” on page 77).
- 2 Drag and drop a song file from the computer's disk to the BACKUP folder in the 2488MKII FAT partition.

If the song file backup has 2 parts, both parts must be placed in the BACKUP folder of the FAT partition for the song to be restored.

- 3 Close the USB connection, and disconnect the 2488MKII from the computer (see “Closing the USB connection” on page 77.)
- 4 Press the MENU key. From the DATA BACKUP menu, select USB RESTORE.

USB RESTORE	
SONG	SIZE
SONG001U.001	422 MB
SONG002U.001	403 MB

FAT → PARTITION 01
FREE AREA: 995MB

At the bottom of the screen, the restore source partition (FAT), and the restore destination partition (TASCAM partition), and the amounts of unused space on the destination partition are shown.

- 5 Use the dial to select the backup file from which to restore the song, and then press YES/ENTER.
- 6 A pop-up message giving the song name appears. Press YES/ENTER to restore the song, NO/EXIT to abort the operation.

The HD indicator flashes as the song is copied from the FAT partition to the TASCAM partition.

- 7 When the copy is finished, the song is automatically loaded and becomes your current working song. You can then use the song management features to load another song, if you want (“First steps in recording {song management}” on page 44.

12 – Tempo and MIDI

The 2488MKII has tempo control functions that include a tempo map and a metronome. Furthermore, it supports many MIDI functions including synchronization with external devices through MTC and MIDI Clock, SMF playback, MMC remote control, and control over the

2488MKII's mixer/effect parameters through program changes and control changes.

Tempo/synchronization and other MIDI-related menu operations are accessed through the MENU's SYNC/MIDI menu.

Metronome

The metronome is an important tool to keep you in time while you play. The 2488MKII's metronome can be a MIDI note output to an external tone generator, or it can be an audio click.

- 1 With the transport stopped, from the SYNC/MIDI screen, select **METRONOME**, and press **YES/ENTER**.

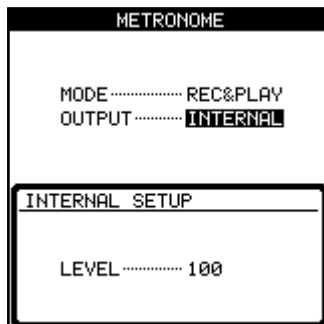

You can select the following metronome modes.

FREE: When the **CLICK** key is **ON**, a click will sound during both recording and playback according to the tempo and time signature set on the **FREE METRONOME** screen (see “Using the metronome” below).

REC: When the **CLICK** key is **ON**, a click will sound during recording according to the tempo and time signature set on the **TEMPO MAP** screen or according to the selected **SMF** (see “Tempo map” on page 88).

REC&PLAY: When the **CLICK** key is **ON**, a click will sound during recording and during playback according to the tempo and time signature set on the **TEMPO MAP** screen or according to the selected **SMF** (see “Tempo map” on page 88).

- 2 Select whether the **OUTPUT** is an internal audio click (**INTERNAL**) or a MIDI note sent from the MIDI OUT terminal (**MIDI**).

If set to **INTERNAL**, the 2488MKII generates an internal audio click. The internal click is output from the **MONITOR OUT** and **PHONES** jacks. The level can be set between 0 and 127.

- 4 If **MIDI** is chosen, the following parameters can be set:

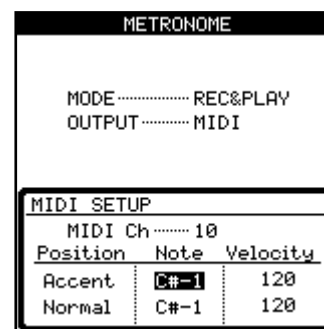

Select the **MIDI** channel (**MIDI Ch 10** is usually reserved for drums and percussion), and the **Note** and **Velocity** used for the **Accent** (the first note of each bar) and **Normal** beats.

Use the **CLICK** key to turn the metronome on (indicator lights orange) and off (indicator goes off). The indicator lights orange while waiting, and while the click is output, flashes red to mark the start of a bar, and green for other beats.

Using the metronome

Use the **CLICK** key above the transport keys to turn metronome output **ON** and **OFF**. When **ON**, it operates according to the selected metronome mode.

■ In FREE mode

A click is output according to the tempo and time signature set on the **FREE METRONOME** screen. The **CLICK** indicator flashes red on the first beat (accent) of each bar, and flashes green on the other beats.

FREE METRONOME screen

- 1 Press and hold the **CLICK** key to open the **FREE METRONOME** screen.

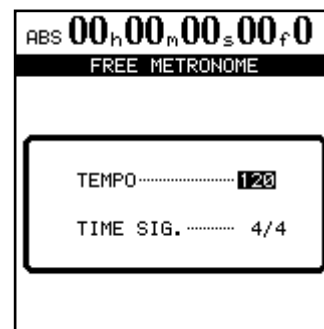

12 – Tempo and MIDI

- 2 Set the tempo with the **TEMPO** item between 20 and 250 BPM.
- 3 Set the time signature with the **TIME SIG.** item.

NOTE

The **FREE METRONOME** screen does not appear if the metronome mode is set to anything other than **FREE** or if the **SMF** player is **ON** (see "SMF playback" on page 90).

■ In REC mode or REC&PLAY mode

During recording in REC mode, or during recording or playback in REC&PLAY mode, a click is output according to the tempo and time signature set on the TEMPO MAP screen or based on an SMF. During click output, the **CLICK** indicator flashes red on the first beat (accent) of each bar, and flashes green on the other beats.

When there is no click output, the **CLICK** indicator lights orange.

Tempo map

Creation of a tempo map is necessary to change tempo or time signature in the middle of a song.

NOTE

Set the metronome to any mode other than **FREE** and turn the **SMF** player **OFF** when using a tempo map.

Setting the tempo

- 1 From the **SYNC/MIDI** menu item, select **TEMPO MAP** and press **YES/ENTER**.

The **TEMPO MAP** screen will open. This screen shows a list of tempo change points in the song.

TEMPO MAP			
No.	BAR	BEAT	TEMPO
00001	001	01	110.0
00002	009	04	130.0
00003	010	01	130.0
00004	014	01	100.0
00005	---	---	---

TIME SIGNATURE: 4/4

The first line shows the tempo at the start of the song.

The second and following lines show each tempo change in the song, with the change point (bar and beat) and the new tempo. These settings can be changed.

If the tempo of a song never changes, there will only be one line.

At the bottom of the screen, the time signature of the line currently selected by the cursor is shown (please see the next section, "Time signature" for details about how to set this).

You can input up to 9999 tempo changes in one song. Tempos can be set between 20.0 and 250.0 beats per minute.

- 2 Use the cursor keys to navigate around the screen, and the dial to change values.
- 3 Use the **INSERT** key to add a new line (tempo change) to the map, and the **DELETE** key to delete lines.

Time signature setting

You must set the time signature setting for a song to display bars and beats accurately during playback.

Music in the 4/4 time signature is common worldwide, but music in triple meter (e.g. 3/4), duple meter (e.g. 2/4), and odd-meters (e.g. 5/4) are also frequent. Time signatures may even change in the middle of a piece of music.

The 2488MKII can display bars and beats for all of these types of music.

The setting procedures are explained below. Adding time signature changes works the same way as adding changes in the tempo map.

- 1 Select **TIME SIGNATURE** from the **SYNC/MIDI** menu and press the **YES/ENTER** key to open the **TIME SIGNATURE** screen. This screen shows time signature changes in the song as a list.

TIME SIGNATURE		
No.	BAR	TIME SIG.
001	001	5/4
002	009	4/4
003	010	4/4
004	014	12/4
005	---	---

The first line is the time signature setting at the start of the song.

The following lines show time signature changes, with the point of change (bar) and new time signature setting.

If the time signature in a song never changes, only one line appears.

12 – Tempo and MIDI

- 2 Use the cursor keys to move the cursor around the screen, and use the JOG/DATA dial to set the values.
- 3 To add a time signature change, place the cursor on the time signature line that is after the location where you want to add a time signature change and press the INSERT key.

To erase a time signature change, select the line you want to remove with the cursor and press the DELETE key.

- 4 Press the YES/ENTER key when you are finished making settings.

MIDI synchronization

The 2488MKII can synchronize to external MIDI Time Code (MTC) or can generate MTC in order to synchronize other MIDI devices.

Other devices may be sequencers or DAWs which are enabled for MTC. In addition it is capable of generating MIDI Clock commands which are typically used by drum and rhythm machines, as well as by some sequencers.

With the transport stopped, from the SYNC/MIDI menu, select the SYNC option and press YES/ENTER:

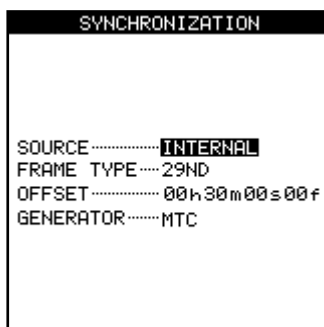

- **SOURCE** can be INTERNAL (the 2488MKII acts as the master unit) or EXTERNAL (the 2488MKII takes its synchronization from another unit).
- **FRAME TYPE** refers to the format of the MTC sent and received by the 2488MKII. This can be either 24 (film), 25 (EBU TV), 29D (29 fps drop-frame, used with NTSC color), 29ND (29fps non-drop, also used with NTSC color), or 30 (NTSTC monochrome and often used for audio-only work)
- **OFFSET** allows you to select the offset of the 2488MKII relative to the incoming time code (outgoing time code is always the same as the absolute position). For example, your song always starts at the “all zeroes” position, but if you are dubbing it onto video at 30 minutes into the video, you should have an offset of 30 minutes set here.
- **GENERATOR** can be OFF, MTC or CLOCK. OFF and MTC explain themselves. See below for an explanation of the CLOCK setting.

TIP

Timecode (including MTC) does not include any information about bars and beats or tempo. MIDI Clock does not contain any information about the absolute time at which events take place.

■ MIDI clock

MIDI Clock and associated MIDI commands (Start/Stop, Song Position Pointer etc.) can be transmitted from the 2488MKII when it is in INTERNAL mode and the **GENERATOR** parameter is set to CLOCK. In this setting, the 2488MKII can be used to control an external sequencers, drum machines, etc. whose audio outputs are fed to the 2488MKII.

NOTE

Remember that there is no absolute time information contained in this MIDI Clock data. Any external devices synchronized to the 2488MKII which need timing information should either be synchronized using MTC, or have their own tempo maps.

12 – Tempo and MIDI

SMF playback

The Standard MIDI File (SMF) format is used to exchange MIDI song data between sequencers, including sequencer software, and other MIDI devices.

Follow the procedures explained in “USB import (SMF files)” on page 79 to transfer an SMF file from a connected computer to the 2488MKII’s FAT partition and then load it from the FAT partition to the SMF player.

To open the SMF PLAYER screen, highlight SMF PLAYER from the SYNC/MIDI menu and press the **YES/ENTER** key.

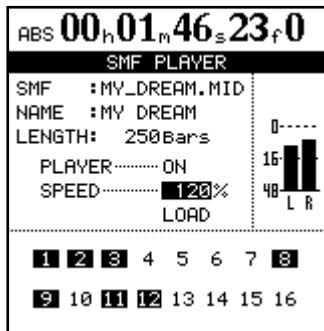

On this screen, you can set the **SPEED** and **PLAYER** ON/OFF items. The **SPEED** parameter is a percentage of the original tempo.

- The **SPEED** item setting allows the speed of the entire piece to be adjusted including any tempo changes included as part of the SMF.
- If the **PLAYER** item is ON, you can use the 2488MKII's SMF playback function to control external MIDI devices. If you connect the audio outputs of those devices to the 2488MKII's audio inputs, you can then record those externally-generated MIDI tracks.

The **LENGTH** item on the screen shows the number of bars in the SMF. The numbers 1–16 in the lower part correspond to MIDI channels, with those used by the SMF shown in inverse.

NOTE

When the SMF player is ON, you cannot use the FREE metronome mode or a tempo map.

MIDI remote control

From the SYNC/MIDI menu, this REMOTE option allows the setting of a number of parameters connected with remote control of the 2488MKII.

MIDI messages can be used for remote control of the 2488MKII's mixer, effects and recorder.

REMOTE	
MMC	
MODE	MASTER
DEVICE ID	ALL
REMOTE CONTROL	
PROGRAM CHANGE SCENE ..	ON
PROGRAM CHANGE EFF	OFF
CONTROL CHANGE	ON

■ MMC MODE

Sets the transmission mode for **MMC** (MIDI Machine Control).

OFF: MMC is not transmitted or received.

MASTER: The 2488MKII is an MMC master.

SLAVE: The 2488MKII is an MMC slave.

When the 2488MKII is an MMC master, MMC commands are sent from its **MIDI OUT**, for remote control of external MMC slaves (including other 2488MKII units). When the 2488MKII acts as an MMC slave, MMC commands are received through its **MIDI IN**, and external MIDI devices or another 2488MKII can remotely control the 2488MKII's recorder.

■ MMC Device ID

Sets the MMC device ID. Select 1 to 127 or ALL. MMC commands are sent and received between masters and slaves with the same device IDs, but when ALL is selected, MMC commands are sent and received for all IDs.

NOTE

MMC is used for remote transport control of MMC-equipped devices, while MTC (MIDI Time Code) is used to synchronize MTC-equipped devices.

Note that the MMC mode and MMC device ID are not related to mixer and effect remote control.

■ REMOTE CONTROL

When **PROGRAM CHANGE SCENE** is ON, received Program Change messages change scenes on the 2488MKII. When **PROGRAM CHANGE EFF** is ON, received Program Change messages change the 2488MKII effects. When **CONTROL CHANGE** is ON, received Control Change messages control the 2488MKII's mixer and effect parameters.

13 – General preferences

There are four sets of general preferences that you can make in order to customize the 2488MKII to your working style. Access all of these through the PREFERENCE menu.

Global preferences

These all affect the overall operation of the 2488MKII.



■ Key sense time

Some of the keys on the unit have two different functions, depending on whether they are pressed and released in a short space of time, or whether they are pressed and held down for a longer period.

The pitch control is a good example of this. If the **PITCH/SSA** key is pressed and released briefly, the pitch control is turned on. If it is pressed and held for the time set here, a screen appears allowing you to make the settings for the pitch and the slow speed audition functions.

The setting for the key sense time is from 0.3 to 2.0 seconds, in 0.1 second steps. The factory setting is 0.5 seconds.

■ Meter peak hold mode

The meters shown on the home screen and other pages can be configured to hold the peak value.

This parameter can take the following values: OFF; where the meters do not hold the peak value at all, ON; the peak

meters hold the value for a second or so and then drop back, or KEEP, where the peak value is always shown on screen until this value is changed. You can also press the **HOME** key when the **SHIFT** indicator is lit.

Use the cursor keys to highlight the parameter, and the dial to change it.

TIP

The KEEP setting is useful if you want a permanent record of the highest value, but you cannot keep your eyes on the meters during the whole take or rehearsal.

■ Meter release time

The meter “drop-back” time can be configured to be from 30 ms to 100 ms in 10 ms steps using the cursor keys to highlight the parameter, and the dial to change it.

Note that the meters are always peak meters, and the rise time is fixed.

■ Shift key behavior

The **SHIFT** key can be used in one of three ways, as set by this parameter:

AUTO SAFE: This is the factory setting. The **SHIFT** key functions for a few seconds after it is pressed. It becomes inactive after you press another key or when the shift indicator light goes out.

HOLD: The **SHIFT** key remains active after you press it until you press another key or press the **SHIFT** key again.

UNLOCK: The **SHIFT** key is active only when you press and hold it down as you press another key.

Mixer preferences

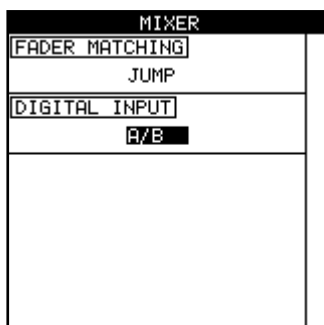

■ Fader matching

The option affects the way in which the physical and the internal faders interact (see “Fader matching” on page 37).

There are three options here:

REAL: if the internal fader level is changed using a scene change or a MIDI Control Change, this is ignored. The actual physical fader is the only way in which the fader level is set.

JUMP: the internal fader level jumps to the level set by the physical fader as soon as the physical fader is moved. Since this can result in sudden changes in volume, resulting in possible damage to hearing and monitoring equipment, this option should be used with caution.

CATCH: the fader level remains the same initially. However, if you then move the physical fader so that the physical level becomes the internal level (the faders

13 – General preferences

“catch” the internal level), the physical level changes at that point. This ensures that there are no sudden leaps in volume due to a difference between the physical fader and the internal setting.

NOTE

Note that the setting made for this option will apply to the current song, and any songs loaded afterwards, until the setting is changed.

■ Digital input channel selection

Use the **DIGITAL INPUT** item to assign the digital input to a pair of input channels (A/B, C/D, E/F, G/H).

Select OFF if you are not using the digital input.

Press the **YES/ENTER** key to confirm the setting.

This assignment is not made until the **YES/ENTER** key is pressed, with the digital source connected, and is not stored as part of the song information.

The 2488MKII can accept digital audio from 44.1 kHz sources.

Recorder preferences

These preferences affect the recorder operation:

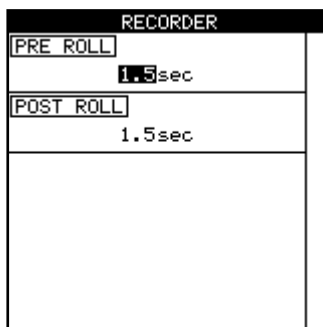

There are only two parameters here, used to change the pre-roll and post-roll times of the auto punch operation (see “Auto punch operations” on page 55).

User words

When titling songs, marks, virtual tracks, effect settings and other items, you can use preset words or phrases.



The 2488MKII comes with many standard useful phrases, but if you are playing a style of music not catered for by these words, you can use this preference screen to add your own words (up to 12 characters long), for example BANJO SOLO.

Select the word to be edited and then press **TITLE** (shifted **MENU**) to edit it, as described in “Titling” on page 15.

Press **YES/ENTER** when you have finished editing the word.

14 - Specifications, etc.

Block diagram

2488MK2 Mixer Block Diagram

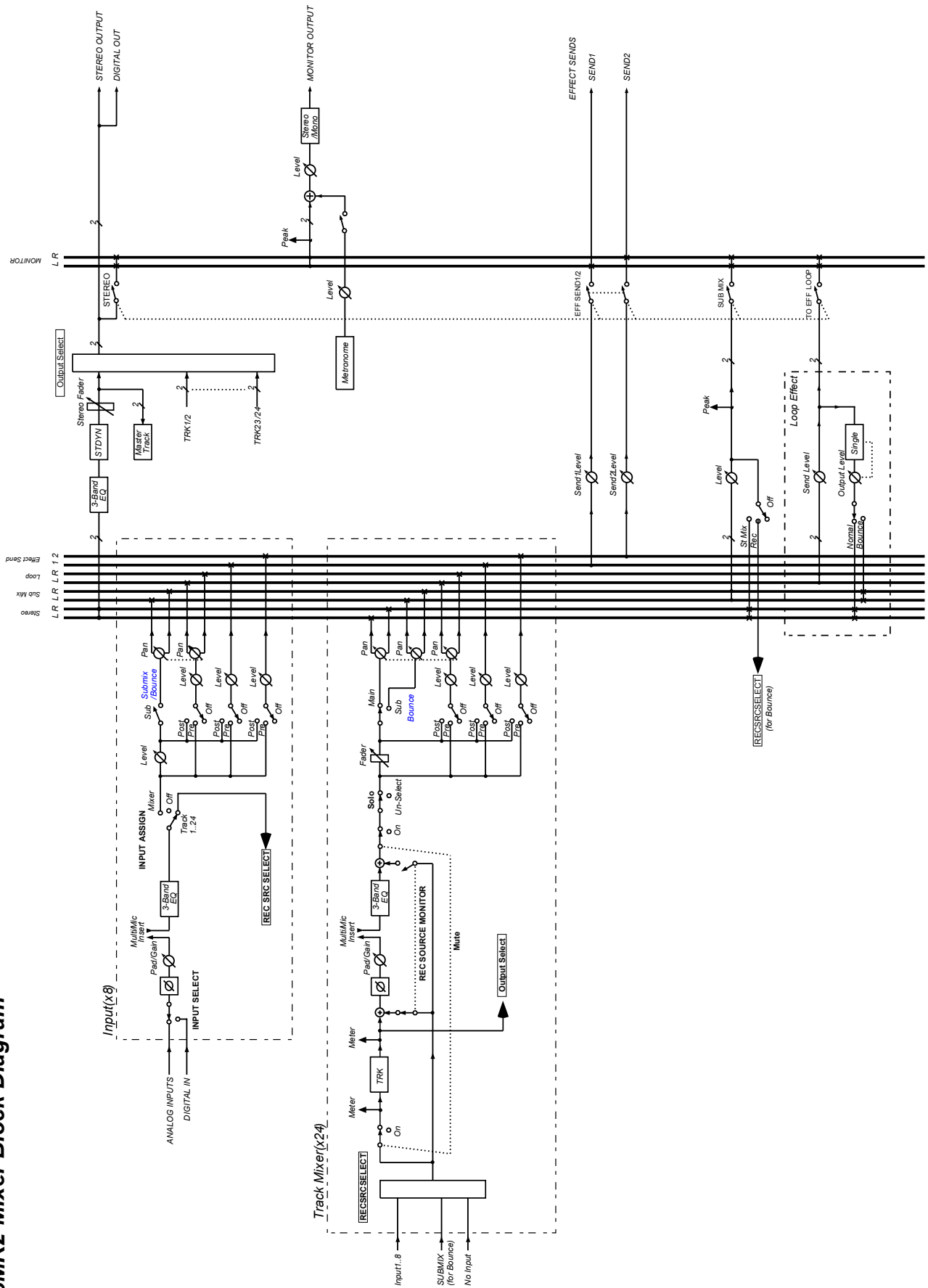

14 - Specifications, etc.

Level diagram

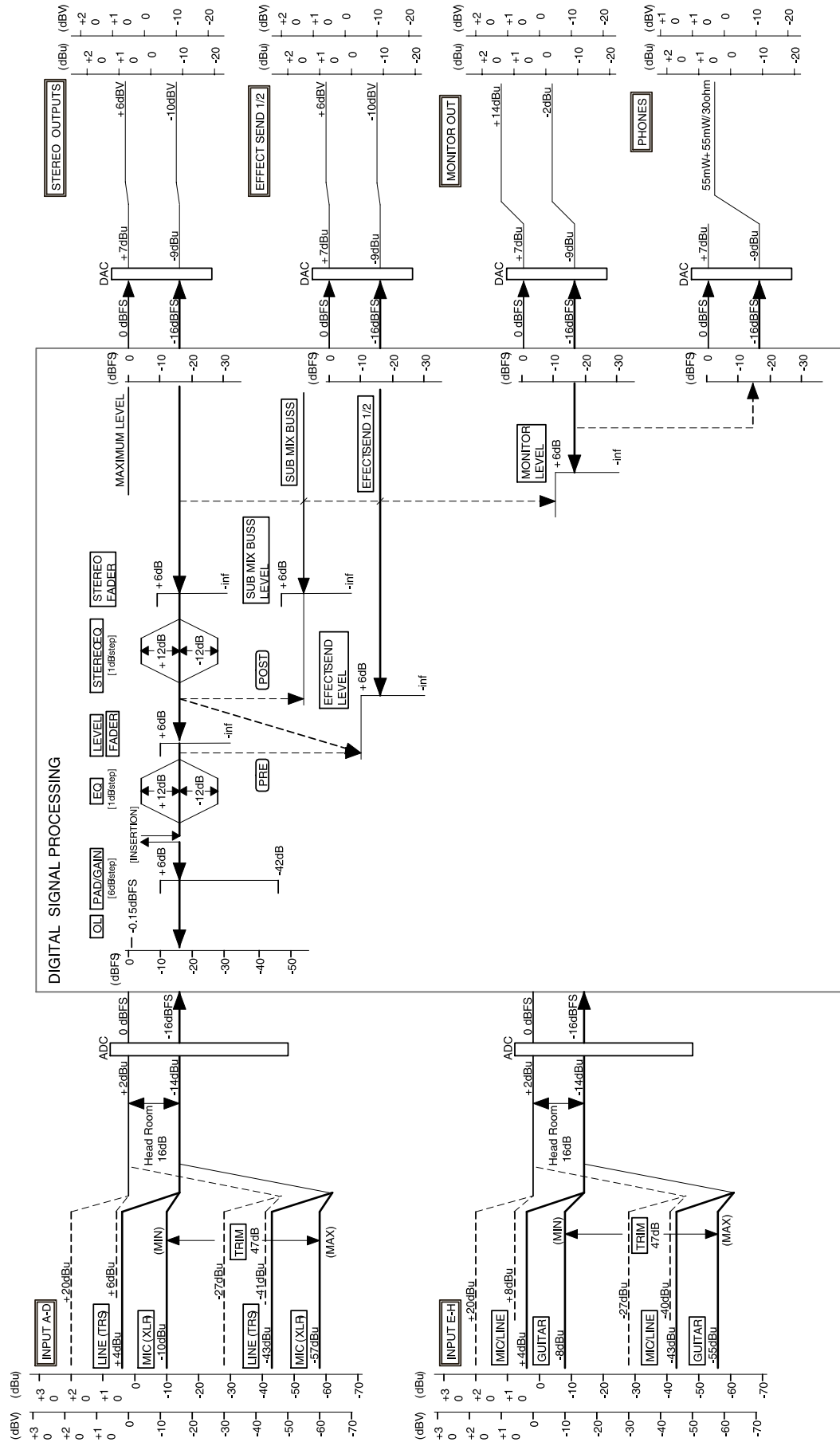

14 – Specifications, etc.

Specifications

Audio connections

MIC/LINE inputs (A to D)	Combined XLR-1/4" TRS connector
XLR	Input impedance: 2 k Ω Input level: -57 dBu (MIC) to -10 dBu (LINE) Nominal input level: -10 dBu Maximum input level: +6 dBu
1/4" TRS	Input impedance: 8 k Ω Input level: -43 dBu (MIC) to +4 dBu (LINE) Nominal input level: +4 dBu Maximum input level: +20 dBu
MIC/LINE inputs (E to H)	1/4" TRS connectors (input H also has a GUITAR front panel unbalanced 1/4") Input impedance: 4 k Ω Input level: -43 dBu (MIC) to +4 dBu (LINE) Nominal input level: +4 dBu Maximum input level: +20 dBu
Input H (GUITAR)	Input impedance: 1 M Ω Input level: -55 dBu to -8 dBu Normal input level: -8 dBu Maximum input level: +8 dBu
STEREO L/R outputs	2 x unbalanced RCA jacks Output impedance: 100 Ω Nominal output level: -10 dBV Maximum output level: +6 dBV
EFFECT SENDS 1 and 2	1 x unbalanced 1/4" jack per send Output impedance: 100 Ω Nominal output level: -10 dBV Maximum output level: +6 dBV
MONITOR L/R outputs	2 x TRS balanced TRS 1/4" jacks Output impedance: 100 Ω Nominal output level: -2 dBu Maximum output level: +14 dBu
PHONES	Stereo 1/4" jack Maximum output level 55 mW + 55 mW (into 30 Ω)
DIGITAL input	RCA jack Data format: IEC60958 consumer use (S/PDIF)
DIGITAL output	RCA jack Data format: IEC60958 consumer use (S/PDIF)

Audio performance

Sampling frequency:	44.1 kHz
Bit depth (resolution):	16-bit/24-bit (user-selectable, per song)
Crossfade time:	10 ms
Number of tracks	24 (8 may be recorded simultaneously)
Frequency response (at min.)	INPUTS A to H STEREO/MONITOR/EFFECT SEND: 20 Hz — 20 kHz +1.0/-1.0 dB (trim at min.)
Noise level (inputs with 150 Ω terminator, faders at nominal, 20kLPF+A curve)	INPUTS A to H STEREO/EFFECT SEND: <90 dBV MONITOR <82 dBu (trim at min.)
Dynamic range Faders at nominal, 20kLPF+A curve	INPUTS A to H STEREO/EFFECT SEND/MONITOR: >96 dB
Crosstalk Faders at nominal, 20kLPF+A curve	INPUTS A to H STEREO/EFFECT SEND/MONITOR: >80 dB @ 1 kHz (trim at minimum, 1 input at max)

14 – Specifications, etc.

Total Harmonic Distortion Inputs at Max, INPUTS A to H STEREO/EFFECT SEND/MONITOR: < 0.01% (trim at min.)
 20kLPF 20kLPF

Physical specifications, etc.

Dimensions (w x d x h) 545 x 355 x 145 (mm), 21.5 x 14 x 5.7 (in.)

Weight 8 kg (17.6 lbs)

Power requirements USA/Canada 120 VAC, 60 Hz
 U.K./Europe 230 VAC, 50 Hz
 Australia 240 VAC, 50 Hz

Power consumption 41 W

Dimensional drawing

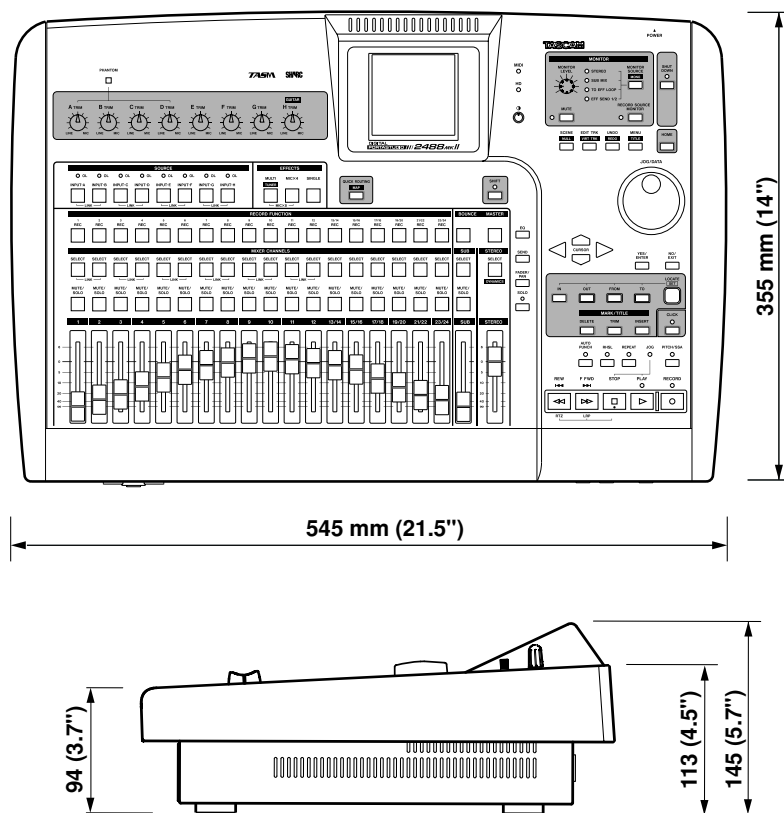

Appendix

MIDI Control/Program change message

The following are the MIDI Control Change messages accepted by the 2488MKII to control different settings. When used with an external sequencer, this provides a certain degree of automation for mixing, etc.

Mixer Control Change parameters

The Bank Select controller is used with channel 15 to choose which group of eight channels or inputs are affected. It is therefore necessary to send a MIDI message of BE 00 XX (where XX selects the group of eight channels or inputs) before sending the Control Change messages on the appropriate MIDI channel.

Bank 0: Mixer channels 1 through 8
 Bank 1: Mixer channels 9 through 16
 Bank 2: Mixer channels 17 through 24
 Bank 3: Inputs A through H

Once the group has been selected, use MIDI channels 1 through 8 to control the mixer channels or inputs or MIDI channel 16 for the stereo master or send master).

MIDI channel		1-8	16
		Mixer/Input channel	STEREO/MASTER
Control Change Number	Parameter	Values	
7	Internal Level	0 - 127 (0 = -∞ dB, 100 = 0 dB, 127 = +6 dB)	
10	Pan	1 = L63, 64 = Center, 127 = R63	
11	Attenuation	0 - 8 = -42, -36, -30, -24, -18, -12, -6, 0, +6 (dB)	
16	Low Freq	0 - 31 = 32, 40, 50, 60, 70, 80, 90, 100, 125, 150, 175, 200, 225, 250, 300, 350, 400, 450, 500, 600, 700, 800, 850, 900, 950, 1.0k, 1.1k, 1.2k, 1.3k, 1.4k, 1.5k, 1.6k (Hz)	
17	Low Gain	0 - 24 = -12 to +12 (dB)	
18	Mid Freq	0 - 63 = 32, 40, 50, 60, 70, 80, 90, 100, 125, 150, 175, 200, 225, 250, 300, 350, 400, 450, 500, 600, 700, 800, 850, 900, 950, 1.0k, 1.1k, 1.2k, 1.3k, 1.4k, 1.5k, 1.6k, 1.7k, 1.8k, 1.9k, 2.0k, 2.2k, 2.4k, 2.6k, 2.8k, 3.0k, 3.2k, 3.4k, 3.6k, 3.8k, 4.0k, 4.5k, 5.0k, 5.5k, 6.0k, 6.5k, 7.0k, 7.5k, 8.0k, 9.0k, 10k, 11k, 12k, 13k, 14k, 15k, 16k, 17k, 18k (Hz)	
19	Mid Gain	0 - 24 = -12 to +12 (dB)	
20	Mid Q	0 - 6 = 0.25, 0.5, 1, 2, 4, 8, 16	
21	High Freq	32 - 63 = 1.7k, 1.8k, 1.9k, 2.0k, 2.2k, 2.4k, 2.6k, 2.8k, 3.0k, 3.2k, 3.4k, 3.6k, 3.8k, 4.0k, 4.5k, 5.0k, 5.5k, 6.0k, 6.5k, 7.0k, 7.5k, 8.0k, 9.0k, 10k, 11k, 12k, 13k, 14k, 15k, 16k, 17k, 18k (Hz)	
22	High Gain	0 - 24 = -12 to +12 (dB)	
23	LOOP Effect Level	0 - 127 (0 = -∞ dB, 100 = 0 dB, 127 = +6 dB)	(MASTER LEVEL)
24	EFFECT1 Level	0 - 127 (0 = -∞ dB, 100 = 0 dB, 127 = +6 dB)	(MASTER LEVEL)
25	EFFECT2 Level	0 - 127 (0 = -∞ dB, 100 = 0 dB, 127 = +6 dB)	(MASTER LEVEL)
80	EQ SW	0, 1 = OFF, ON	
81	LOOP Effect Pos	0, 1, 2 = OFF, PRE, POST	
82	EFFECT1 Pos	0, 1, 2 = OFF, PRE, POST	
83	EFFECT2 Pos	0, 1, 2 = OFF, PRE, POST	
84	Phase	0, 1 = N, R	

Effect parameter change MIDI messages

Use the following MIDI channels to send messages to the 2488MKII effects (see “Effects“ on page 39):

Channels 1 through 8 are used for mic effects. The Bank Select controller is used with channel 14 to choose which group of eight channels or inputs is affected.

Bank 0: Mixer channels 1 through 8

Bank 1: Mixer channels 9 through 16

Bank 2: Mixer channels 17 through 24

Bank 3: Inputs A through H

Channel 9 is used to control the stereo dynamics processor effect.

Channel 10 is used to control the single effect.

Channel 11 is used to control the multi-effect.

The way in which the effects are controlled is by the use of NRPN (non-Registered Parameters).

Controller 98 is used for the LSB of each NRPN, and controller 99 for the MSB.

In effect settings where more than one effect may be selected, the same NRPN may produce a different outcome, depending on the selected effect.

NOTE

All values, etc. listed in these tables are in decimal notation.

■ Example effect parameter change

This example shows the MIDI bytes (in hexadecimal notation) needed to set the ratio of a compressor effect on mixer channel 9.

Note how Control Changes 6 and 38 (decimal) are used for data entry.

Control Changes 96 and 97 (decimal) are used for increment and decrement as well.

MIDI message (hexadecimal)	Meaning
BD 00 01	Sends a Control Change 0 (Bank Select) message on channel 14 to select bank 1
B0 63 00	Sends NPRN MSB to 2nd channel in group (mixer channel 9) on MIDI channel 1
B0 62 01	Sends 1 as NPRN LSB to 2nd channel in group, which controls the ratio when compressor is selected as mic effect
B0 06 00	Data entry Control Change LSB on MIDI channel 1
B0 26 00	Data entry Control Change MSB on MIDI channel 1

The ratio of the compressor on mixer channel 9 is now set to a value of 0.

Appendix

Mic effects

Mic effects are controlled by channels 1 through 8 (see “Effect parameter change MIDI message” on page 99 for channel/input assignments enabled through Bank Select).

One of three different types of effect can be selected as a mic effect: compressor, de-esser, exciter or noise suppressor.

Effect	NRPN	Parameter	Values
Compressor (CMP)	00 00	Threshold	0 – 100 = -40.0, -39.6, -39.2, -38.8, -38.4, -38.0, -37.6, -37.2, -36.8, -36.4, -36.0, -35.6, -35.2, -34.8, -34.4, -34.0, -33.6, -33.2, -32.8, -32.4, -32.0, -31.6, -31.2, -30.8, -30.4, -30.0, -29.6, -29.2, -28.8, -28.4, -28.0, -27.6, -27.2, -26.8, -26.4, -26.0, -25.6, -25.2, -24.8, -24.4, -24.0, -23.6, -23.2, -22.8, -22.4, -22.0, -21.6, -21.2, -20.8, -20.4, -20.0, -19.6, -19.2, -18.8, -18.4, -18.0, -17.6, -17.2, -16.8, -16.4, -16.0, -15.6, -15.2, -14.8, -14.4, -14.0, -13.6, -13.2, -12.8, -12.4, -12.0, -11.6, -11.2, -10.8, -10.4, -10.0, -9.6, -9.2, -8.8, -8.4, -8.0, -7.6, -7.2, -6.8, -6.4, -6.0, -5.6, -5.2, -4.8, -4.4, -4.0, -3.6, -3.2, -2.8, -2.4, -2.0, -1.6, -1.2, -0.8, -0.4, 0.0 (dB)
	00 01	Ratio	0 – 100 = 0 – 100
	00 02	Attack	0 – 100 = 0 – 100
	00 08	Release	0 – 100 = 0 – 100
	00 03	Post Gain	0 – 100 = 0 – 100
De-esser (DSR)	00 04	Frequency	0 – 20 = 1.00, 1.07, 1.15, 1.23, 1.32, 1.41, 1.52, 1.62, 1.74, 1.87, 2.00, 2.14, 2.30, 2.46, 2.64, 2.83, 3.03, 3.25, 3.48, 3.73, 4.00 (kHz)
	00 05	Depth	0 – 100 = 0 – 100
Exciter (EXC)	00 06	Frequency	0 – 20 = 1.00, 1.07, 1.15, 1.23, 1.32, 1.41, 1.52, 1.62, 1.74, 1.87, 2.00, 2.14, 2.30, 2.46, 2.64, 2.83, 3.03, 3.25, 3.48, 3.73, 4.00 (kHz)
	00 07	Depth	0 – 100 = 0 – 100
Noise suppressor	00 09	Threshold	0 – 100 = -84.0, -83.4, -82.8, -82.2, -81.6, -81.0, -80.4, -79.8, -79.2, -78.6, -78.0, -77.4, -76.8, -76.2, -75.6, -75.0, -74.4, -73.8, -73.2, -72.6, -72.0, -71.4, -70.8, -70.2, -69.6, -69.0, -68.4, -67.8, -67.2, -66.6, -66.0, -65.4, -64.8, -64.2, -63.6, -63.0, -62.4, -61.8, -61.2, -60.6, -60.0, -59.4, -58.8, -58.2, -57.6, -57.0, -56.4, -55.8, -55.2, -54.6, -54.0, -53.4, -52.8, -52.2, -51.6, -51.0, -50.4, -49.8, -49.2, -48.6, -48.0, -47.4, -46.8, -46.2, -45.6, -45.0, -44.4, -43.8, -43.2, -42.6, -42.0, -41.4, -40.8, -40.2, -39.6, -39.0, -38.4, -37.8, -37.2, -36.6, -36.0, -35.4, -34.8, -34.2, -33.6, -33.0, -32.4, -31.8, -31.2, -30.6, -30.0, -29.4, -28.8, -28.2, -27.6, -27.0, -26.4, -25.8, -25.2, -24.6, -24.0 (dB)
	00 10	Suppress	0 – 100 = 0 – 100
	00 11	Attack	0 – 100 = 0 – 100
	00 12	Release	0 – 100 = 0 – 100

Stereo dynamics processor

The dynamics processor inserted at the stereo master bus can be either a compressor or an expander. Use MIDI channel 9 to control this processor.

Effect	NRPN	Parameter	Values
Compressor (CMP)	00 00	Threshold	0 – 32 = -32 – 0 dB
	00 01	Ratio	0 – 14 = 1.0:1, 1.1:1, 1.3:1, 1.5:1, 1.7:1, 2.0:1, 2.5:1, 3.0:1, 3.5:1, 4.0:1, 5.0:1, 6.0:1, 8.0:1, 16:1, ∞:1,
	00 02	Attack	1 – 100 = 2 – 200 (msec)
	00 03	Release	1 – 100 = 10 – 1000 (msec)
	00 04	Post Gain	0 – 32 = 0 – 32 (dB)
	00 05	Switch	0, 1 = Off, On
Expander (EXP)	00 00	Threshold	0 – 32 = -32 – 0 dB
	00 01	Ratio	0 – 14 = 1:1.0, 1:1.1, 1:1.3, 1:1.5, 1:1.7, 1:2.0, 1:2.5, 1:3.0, 1:3.5, 1:4.0, 1:5.0, 1:6.0, 1:8.0, 1:16, 1:32,
	00 02	Attack	1 – 100 = 2 – 200 (msec)
	00 03	Release	1 – 100 = 10 – 1000 (msec)
	00 04	(reserved)	
	00 05	Switch	0, 1 = Off, On

Single effect

Use MIDI channel 10 to control this processor. The single processor can use any one of a number of effect types: reverb, delay, chorus, pitch shifter, flanger, phaser and gated reverb.

Effect	NRPN	Parameter	Values
Reverb (REV)	00 00	Room Type	0 – 3 = Hall, Room, Live, Studio
	00 01	Pre Delay	0 – 250 = 0 – 250 (msec)
	00 02	Rev Time	1 – 100 = 0.1 – 10.0 (sec)
	00 08	Diffusion	0 – 100 = 0 – 100
	00 04	Level	0 – 127 = 0 – 127
Delay (DLY)	00 00	Type	0 – 2 = Normal, Pan, Multi
	00 01	Pre Delay	0 – 1000 = 0 – 1000 (msec)
	00 02	FB Delay	0 – 1000 = 0 – 1000 (msec)
	00 03	Feedback	0 – 100 = 0 – 100
	00 04	Level	0 – 127 = 0 – 127
Chorus (CHO)	00 00	Rate	1 – 100 = 0.1 – 10.0 (Hz)
	00 01	Depth	0 – 100 = 0 – 100
	00 02	FB Delay	0 – 100 = 0 – 100
	00 03	Feedback	0 – 100 = 0 – 100
	00 04	Level	0 – 127 = 0 – 127

Appendix

Effect	NRPN	Parameter	Values
Pitch Shifter (PIT)	00 00	Pitch	0 – 12 – 24 = –12 – 0 – +12
	00 01	Fine	0 – 50 – 100 = –50 – 0 – +50
	00 02	FB Delay	0 – 500 = 0 – 500 (msec)
	00 03	Feedback	0 – 100 = 0 – 100
	00 04	Level	0 – 127 = 0 – 127
Flanger (FLG)	00 00	Rate	1 – 100 = 0.1 – 10.0 (Hz)
	00 01	Depth	0 – 100 = 0 – 100
	00 02	FB Delay	0 – 1000 = 0 – 1000 (msec)
	00 03	Feedback	0 – 100 = 0 – 100
	00 04	Level	0 – 127 = 0 – 127
Phaser (PHA)	00 00	Rate	1 – 100 = 0.1 – 10.0 (Hz)
	00 01	Depth	0 – 100 = 0 – 100
	00 02	Resonance	0 – 100 = 0 – 100
	00 03	Step	0 – 3 = 4, 8, 12, 16
	00 04	Level	0 – 127 = 0 – 127
Gated reverb (GRV)	00 00	Type	0,1 = Normal, Reverse
	00 01	Threshold	0 – 30 = –46 – –16 (dB)
	00 02	Gate Time	1 – 300 = 10 – 3000 (msec)
	00 03	Density	0 – 100 = 0 – 100
	00 04	Level	0 – 127 = 0 – 127

Multi effect

Use MIDI channel 11 to set the parameters of this effect. Note that this effect chains together a sequence of effects (each step in the chain can hold one effect, the

sequence in the chain of which is given in the first column of this table):

Effect chain #	Effect	NRPN	Parameter	Values
1	Noise suppressor (NSP)	00 00	Threshold	0 – 100 = –84.0, –83.4, –82.8, –82.2, –81.6, –81.0, –80.4, –79.8, –79.2, –78.6, –78.0, –77.4, –76.8, –76.2, –75.6, –75.0, –74.4, –73.8, –73.2, –72.6, –72.0, –71.4, –70.8, –70.2, –69.6, –69.0, –68.4, –67.8, –67.2, –66.6, –66.0, –65.4, –64.8, –64.2, –63.6, –63.0, –62.4, –61.8, –61.2, –60.6, –60.0, –59.4, –58.8, –58.2, –57.6, –57.0, –56.4, –55.8, –55.2, –54.6, –54.0, –53.4, –52.8, –52.2, –51.6, –51.0, –50.4, –49.8, –49.2, –48.6, –48.0, –47.4, –46.8, –46.2, –45.6, –45.0, –44.4, –43.8, –43.2, –42.6, –42.0, –41.4, –40.8, –40.2, –39.6, –39.0, –38.4, –37.8, –37.2, –36.6, –36.0, –35.4, –34.8, –34.2, –33.6, –33.0, –32.4, –31.8, –31.2, –30.6, –30.0, –29.4, –28.8, –28.2, –27.6, –27.0, –26.4, –25.8, –25.2, –24.6, –24.0 (dB)
		00 01	Suppress	0 – 100 = 0 – 100
		00 02	Attack	0 – 100 = 0 – 100
		00 08	Release	0 – 100 = 0 – 100
		00 04	Switch	0, 1 = Off, On

Effect chain #	Effect	NRPN	Parameter	Values
2	Distortion (DST)	00 05	Distortion	0 – 100 = 0 – 100
		00 06	Tone	0 – 100 = 0 – 100
		00 07	Level	0 – 100 = 0 – 100
		00 08	(reserved)	
		00 09	Switch	0, 1 = Off, On
	Overdrive (OD)	00 05	Drive	0 – 100 = 0 – 100
		00 06	Tone	0 – 100 = 0 – 100
		00 07	Level	0 – 100 = 0 – 100
		00 08	(reserved)	
		00 09	Switch	0, 1 = Off, On
	Compressor (CMP)	00 05	Threshold	0 – 100 = -60.0, -59.6, -59.2, -58.8, -58.4, -58.0, -57.6, -57.2, -56.8, -56.4, -56.0, -55.6, -55.2, -54.8, -54.4, -54.0, -53.6, -53.2, -52.8, -52.4, -52.0, -51.6, -51.2, -50.8, -50.4, -50.0, -49.6, -49.2, -48.8, -48.4, -48.0, -47.6, -47.2, -46.8, -46.4, -46.0, -45.6, -45.2, -44.8, -44.4, -44.0, -43.6, -43.2, -42.8, -42.4, -42.0, -41.6, -41.2, -40.8, -40.4, -40.0, -39.6, -39.2, -38.8, -38.4, -38.0, -37.6, -37.2, -36.8, -36.4, -36.0, -35.6, -35.2, -34.8, -34.4, -34.0, -33.6, -33.2, -32.8, -32.4, -32.0, -31.6, -31.2, -30.8, -30.4, -30.0, -29.6, -29.2, -28.8, -28.4, -28.0, -27.6, -27.2, -26.8, -26.4, -26.0, -25.6, -25.2, -24.8, -24.4, -24.0, -23.6, -23.2, -22.8, -22.4, -22.0, -21.6, -21.2, -20.8, -20.4, -20.0 (dB)
		00 06	Ratio	0 – 100 = 0 – 100
		00 07	Level	0 – 100 = 0 – 100
		00 08	Attack	0 – 100 = 0 – 100
		00 25	Release	0 – 100 = 0 – 100
00 09		Switch	0, 1 = Off, On	
3	Amp simulator (AMP)	00 10	Pre Gain	0 - 100 = 0 - 100
		00 11	Tone	0 - 20 = 0.12, 0.14, 0.16, 0.18, 0.20, 0.22, 0.25, 0.28, 0.31, 0.35, 0.39, 0.44, 0.49, 0.55, 0.62, 0.70, 0.79, 0.89, 1.00, 1.12, 1.26 (kHz)
		00 12	Box Size	0 - 3 = 1x8", 1x12", 2x12", "4x10", 4x12"
		00 13	Post Gain	0 - 100 = 0 - 100
		00 14	Switch	0, 1 = Off, On
	Acoustic guitar simulator (ACG)	00 10	Type	0 - 3 = 1 - 4
		00 11	Enhance	0 - 100 = 0 - 100
		00 12	Size	0 - 100 = 0 - 100
		00 13	Level	0 - 100 = 0 - 100
		00 14	Switch	0, 1 = Off, On

Appendix

Effect chain #	Effect	NRPN	Parameter	Values
4	Flanger (FLG)	00 15	Speed	0 – 100 = 0 – 100
		00 16	Depth	0 – 100 = 0 – 100
		00 17	Resonance	0 – 100 = 0 – 100
		00 18	Mix Level	0 – 100 = 0 – 100
		00 19	Switch	0, 1 = Off, On
	Phaser (PHA)	00 15	Speed	1 – 100 = 0.1 – 10.0 (Hz)
		00 16	Depth	0 – 100 = 0 – 100
		00 17	Resonance	0 – 100 = 0 – 100
		00 18	(reserved)	
		00 19	Switch	0, 1 = Off, On
	Chorus (CHO)	00 15	Speed	0 – 99 = 0.1 – 10.0 (Hz)
		00 16	Depth	0 – 100 = 0 – 100
		00 17	Tone	0 – 100 = 0 – 100
		00 18	Mix Level	0 – 100 = 0 – 100
		00 19	Switch	0, 1 = Off, On
	Exciter (EXC)	00 15	Frequency	0 – 20 = 1.00, 1.07, 1.15, 1.23, 1.32, 1.41, 1.52, 1.62, 1.74, 1.87, 2.00, 2.14, 2.30, 2.46, 2.64, 2.83, 3.03, 3.25, 3.48, 3.73, 4.00 (kHz)
		00 16	Depth	0 – 100 = 0 – 100
		00 17	(reserved)	
		00 18	(reserved)	
		00 19	Switch	0, 1 = Off, On
	Pitch shifter (PIT)	00 15	Pitch	0 – 12 – 24 = –12 – 0 – +12
		00 16	Fine	0 – 50 – 100 = –50 – 0 – +50
		00 17	Mix Level	0 – 100 = 0 – 100
		00 18	(reserved)	
		00 19	Switch	0, 1 = Off, On
	Tremolo (TRM)	00 15	Speed	1 – 100 = 0.1 – 10.0 (Hz)
		00 16	Depth	0 – 100 = 0 – 100
		00 17	Shape	0 – 100 = 0 – 100
		00 18	(reserved)	
		00 19	Switch	0, 1 = Off, On
Vibrato (VIB)	00 15	Speed	1 – 100 = 0.1 – 10.0 (Hz)	
	00 16	Depth	0 – 100 = 0 – 100	
	00 17	(reserved)	0 – 100 = 0 – 100	
	00 18	(reserved)		
	00 19	Switch	0, 1 = Off, On	

Effect chain #	Effect	NRPN	Parameter	Values
4	Wah (WAH)	00 15	Attack	1 – 100 = 0.1 – 10.0 (Hz)
		00 16	Sense	0 – 100 = 0 – 100
		00 17	(reserved)	
		00 18	(reserved)	
		00 19	Switch	0, 1 = Off, On
5	Delay (DLY)	00 20	Time	0 – 1000 = 0 – 1000 (ms)
		00 21	Feedback	0 – 100 = 0 – 100
		00 22	Hi Damp	0 – 100 = 0 – 100
		00 23	Mix Level	0 – 100 = 0 – 100
		00 24	Type	0 – 6 = OFF, Normal, Pan, Stereo, FB Mod, Gate, Reverse
		00 20	Time-L	0 – 1000 (ms) *If type is Stereo only
		00 26	Time-R	0 – 1000 = 0 – 1000 (ms) *If type is Stereo only
		00 21	Feedback-L	0 – 100 = 0 – 100 *If type is Stereo only
		00 27	Feedback-R	0 – 100 = 0 – 100 *If type is Stereo only
		00 28	Threshold	0 – 100 = 0 – 100 *If type is Gate only

MIDI Program Change messages

The 2488MKII can accept Program Change messages to select an effect and to change scenes. Before a Program Change message is sent for changing an effect, a Bank Select message must be sent to select whether an effect will be selected from the preset bank or from the user bank of memories. In each case, bank 0 corresponds to the preset memories, and bank 1 to the user bank.

Send the Bank Select messages (CC 0) on MIDI channels 1 through 8 for mic effects (see below), MIDI channel 9 for stereo dynamics, channel 10 for the single effect, and channel 11 for the multi effect.

When selecting a mic effect, a Bank Select message should first be sent on channel 14 to select the group of eight channels or inputs out of which the channel is selected:

Bank 0: Mixer channels 1 through 8

Bank 1: Mixer channels 9 through 16

Bank 2: Mixer channels 17 through 24

Bank 3: Inputs A through H

The Program Change messages that are then valid are as follows (see the tables following for details of the preset values—the “user” messages correspond to the entry number in the library):

Mic effects (preset) Program Change 0 to 3

Mic effects (user) Program Change 0 to 99 (maximum)

Stereo dynamics effect (preset) Program Change 0 to 1

Stereo dynamics effect (user) Program Change 0 to 99 (maximum)

Single effect (preset) Program Change 0 to 6

Single effect (user) Program Change 0 to 99 (maximum)

Multi effect (preset) Program Change 0 to 31

Multi effect (user) Program Change 0 to 99 (maximum)

■ Scene memory Program Change messages

These are transmitted on channel 16. The Program Change message may be from 0 to 99.

Appendix

Preset mic effects

Program Change	Name shown on display	Effect component
0	VOCAL-COMP	Compressor (CMP)
1	DE-ESSER	De-esser (DSR)
2	VOCAL-EXC	Exciter (EXC)
3	VOCAL-NSP	Noise Suppressor (NSP)

Preset stereo dynamics effects

Program Change	Name shown on display	Effect component
0	COMPRESSOR	Compressor (CMP)
1	EXPANDER	Expander (EXP)

Preset Multi effects

The first 32 effects are generic effects, and the rest are presets that you can use “as is” or as jumping-off points for your own sounds.

The chain of all multi effects start with (1) a noise suppressor, followed by either (2) distortion, overdrive or clean compression, then (3) an amp simulator or acoustic guitar simulator, (4) another effect, and finally by (5) a delay setting.

The effects in (4) are abbreviated as follows:

FLG: Flanger

PHA: Phaser

CHO: Chorus

EXC: Exciter

PIT: Pitch shifter

TRM: Tremolo

VIB: Vibrato

WAH: Wah

Program Change	Name shown on display	Main components
0	DIST-FLANGER	DIST- FLG
1	DIST-PHASER	DIST- PHA
2	DIST-CHORUS	DIST- CHO
3	DIST-EXCITER	DIST- EXC
4	DIST-PITCH	DIST- PIT
5	DIST-TREMOLO	DIST- TRM
6	DIST-VIBRATO	DIST- VIB
7	DIST-WAH	DIST- WAH
8	OD-FLANGER	OD- FLG
9	OD-PHASER	OD- PHA
10	OD-CHORUS	OD- CHO
11	OD-EXCITER	OD- EXC

Program Change	Name shown on display	Main components
12	OD-PITCH	OD- PIT
13	OD-TREMOLO	OD- TRM
14	OD-VIBRATO	OD- VIB
15	OD-WAH	OD- WAH
16	COMP-FLANGER	COMP-FLG
17	COMP-PHASER	COMP-PHA
18	COMP-CHORUS	COMP-CHO
19	COMP-EXCITER	COMP-EXC
20	COMP-PITCH	COMP-PIT
21	COMP-TREMOLO	COMP-TRM
22	COMP-VIBRATO	COMP-VIB
23	COMP-WAH	COMP-WAH
24	AC.G-FLANGER	AC.G- FLG
25	AC.G-PHASER	AC.G- PHA
26	AC.G-CHORUS	AC.G- CHO
27	AC.G-EXCITER	AC.G- EXC
28	AC.G-PITCH	AC.G- PIT
29	AC.G-TREMOLO	AC.G- TRM
30	AC.G-VIBRATO	AC.G- VIB
31	AC.G-WAH	AC.G- WAH

Preset single effects

The types here are:

REV: Reverb

DLY: Delay

CHO: Chorus

PIT: Pitch shift

FLG: Flanger

PHA: Phaser

GRV: Gate and reverb

Program Change	Name shown on display	Type of effect
0	REVERB	REV
1	DELAY	DLY
2	CHORUS	CHO
3	PITCH SHIFT	PIT
4	FLANGER	FLG
5	PHASER	PHA
6	GATE+REVERB	GRV

Appendix

MIDI Implementation chart

TEAC [Digital Portastudio)]

DATE : 28 February :2004

Model: 2488MKII

MIDI Implementation Chart

Version : 1.0

Function		Transmitted	Recognized	Remarks
Basic Channel	Default	1-16	1-16	
	Changed	x	1-16	
Mode	Default	x	Mode 3	
	Messages	x	x	
	Altered	*****		
Note Number		0 — 127	0 — 127	
	True Voice	*****	0 — 127	
Velocity	Note On	O	O	
	Note Off	x	x	
After Touch	Key's	O	O	
	Ch's	O	O	
Pitch Bend		O	O	
Control Change	0,32	O a	O d	Bank Select a
	1	O	x	Modulation
	5	O	x	Portamento time
	6,38	O	O	Data entry
	7	O	O	Volume
	10	O	O	Panpot
	11	O	O	Expression
	64	O	x	Hold 1
	65	O	x	Portamento
	66	O	x	Sostenuto
	67	O	x	Soft
	80	O	O	Reverb program
	81	O	O	Chorus program
	91	O	O	Reverb send
93	O	x	Chorus send	
Prog Change	True #	O *****	O 0—127c	
System Exclusive		O	O	f
Common	MTC Quarter Frame	Ob	Oe	
	Song Pos	Oc	x	
	Song Sel	Oa	x	
	Tune	Oa	x	
System Real Time	Clock	O c	x	
	Commands	O	x	
Aux Messages	Local ON/OFF	x	x	
	All Notes OFF	O	O	
	Active Sense	x	x	
	Reset	O	O	

a. On SMF playback

b. When generator is set to output MTC

c. When generator is set to output clock

d. When MIDI remote control is selected

e. When source is set to external

f. MMC as master or slave RP Ver 1.00 (T, R) : MIDI Full Timecode is T when generator is MTC, and R when SOURCE is external.

MODE 1: OMNI ON, POLY MODE 2: OMNI ON, MONO O:Yes

MODE 3: OMNI OFF, POLY MODE 4: OMNI OFF, MONO x: No

MMC Bit map commands

Bit-map array of MMC commands

Byte	Bit7	Bit6 (40H)	Bit5 (20H)	Bit4 (10H)	Bit3 (08H)	Bit2 (04H)	Bit1 (02H)	Bit0 (01H)
c0	- 0	(06) RECORD STROBE	(05) REWIND	(04) FAST FORWARD	(03) DEFERRED PLAY	(02) PLAY	(01) STOP	(00) reserved
c1	- 0	(0D) MMC RESET	(0C) COMMAND ERROR RESET	(0B) CHASE	(0A) EJECT	(09) PAUSE	(08) RECORD PAUSE	(07) RECORD EXIT
c2	- 0	(14)	(13)	(12)	(11)	(10)	(0F)	(0E)
c3	- 0	(1B)	(1A)	(19)	(18)	(17)	(16)	(15)
c4	- 0	- 0	- 0	- 0	(1F)	(1E)	(1D)	(1C)
c5	- 0	(26)	(25)	(24)	(23)	(22)	(21)	(20)
c6	- 0	(2D)	(2C)	(2B)	(2A)	(29)	(28)	(27)
c7	- 0	(34)	(33)	(32)	(31)	(30)	(2F)	(2E)
c8	- 0	(3B)	(3A)	(39)	(38)	(37)	(36)	(35)
c9	- 0	- 0	- 0	- 0	(3F)	(3E)	(3D)	(3C)
c10	- 0	(46) SEARCH	(45) VARIABLE PLAY	(44) LOCATE	(43) UPDATE	(42) READ	(41) MASKED WRITE	(40) WRITE
c11	- 0	(4D) ADD	(4C) MOVE	(4B) MTC COMMAND	(4A) GENERATOR COMMAND	(49) ASSIGN SYS, MAS	(48) STEP	(47) SHUTTLE
c12	- 0	(54) DEFERRED VARI, PLAY	(53) COMMAND SEGMENT	(52) GROUP	(51) EVENT	(50) PROCEDURE	(4F) DROP FRADJUST	(4E) SUBTRACT
c13	- 0	(5B)	(5A)	(59)	(58)	(57)	(56)	(55) REC STROBE VARIABLE
c15	- 0	(66)	(65)	(64)	(63)	(62)	(61)	(60)
c16	- 0	(6D)	(6C)	(6B)	(6A)	(69)	(68)	(67)
c17	- 0	(74)	(73)	(72)	(71)	(70)	(6F)	(6E)
c18	- 0	(7B)	(7A)	(79)	(78)	(77)	(76)	(75)
c19	- 0	- 0	- 0	- 0	(7F) RESUME	(7E)	(7D)	(7C) WAIT

Appendix

Bit-map array of Response/Information field

Byte	Bit7	Bit6 (40H)	Bit5 (20H)	Bit4 (10H)	Bit3 (08H)	Bit2 (04H)	Bit1 (02H)	Bit0 (01H)
r0	- 0	(06) GENERATOR TIMECODE	(05) LOCK DEVIATION	(04) ACTUAL OFFSET	(03) REQUESTED OFFSET	(02) SELECTED MASTER CODE	(01) SELECTED TIMECODE	(00) reserved
r1	- 0	(0D) GP5	(0C) GP4	(0B) GP3	(0A) GP2	(09) GP1	(08) GP0/LOCATE POINT	(07) MTG-INPUT POINT
r2	- 0	(14)	(13)	(12)	(11)	(10)	(0F) GP7	(0E) GP6
r3	- 0	(1B)	(1A)	(19)	(18)	(17)	(16)	(15)
r4	- 0	- 0	- 0	- 0	(1F)	(1E)	(1D)	(1C)
r5	- 0	(26) Short GENERATOR TIMECODE	(25) Short LOCK DEVIATION	(24) Short ACTUAL OFFSET	(23) Short REQUESTED OFFSET	(22) Short SELECTED MASTER CODE	(21) Short SELECTED TIMECODE	(20) reserved
r6	- 0	(2D) Short GP5	(2C) Short GP4	(2B) Short GP3	(2A) Short GP2	(29) Short GP1	(28) Short GP0 LOCATE POINT	(27) Short MTG INPUT POINT
r7	- 0	(34)	(33)	(32)	(31)	(30)	(2F) Short GP7	(2E) Short GP6
r8	- 0	(3B)	(3A)	(39)	(38)	(37)	(36)	(35)
r9	- 0	- 0	- 0	- 0	(3F)	(3E)	(3D)	(3C)
r10	- 0	(46) SELECTED TIMECODE SOURCE	(45) TIME STANDARD	(44) COMMAND ERROR-LEVEL	(43) COMMAND ERROR	(42) RESPONSE ERROR	(41) UPDATE-RATE	(40) SIGNATURE
r11	- 0	(4D) RECORD STATUS	(4C) RECORD MODE	(4B) FAST MODE	(4A) STOP MODE	(49) VELOCITY TALLY	(48) MOTION CONTROL TALLY	(47) SELECTED TIMECODE USER BITS
r12	- 0	(54) STEP-LENGTH	(53) TRACK-INPUT MONITOR	(52) TRACK-SYNG MONITOR	(51) RECORD MONITOR	(50) GLOBAL MONITOR	(4F) TRACK RECORD READY	(4E) TRACK RECORD STATUS
r13	- 0	(5B) GENERATOR COMMAND TALLY	(5A) CHASE-MODE	(59) RESOLVED PLAY-MODE	(58) CONTROL DISABLE	(57) LIFTER DEFEAT	(56) FIXED-SPEED	(55) PLAY-SPEED REFERENCE
r14	- 0	- 0	- 0	- 0	(5F) MTG-SETUP	(5E) MTG COMMAND TALLY	(5D) GENERATOR USER-BITS	(5C) GENERATOR SETUP
r15	- 0	(66)	(65) FAILURE	(64) RESPONSE SEGMENT	(63) VITC-INSERT ENABLE	(62) TRACK-MUTE	(61) EVENT RESPONSE	(60) PROCEDURE RESPONSE
r16	- 0	(6D)	(6C)	(6B)	(6A)	(69)	(68)	(67)
r17	- 0	(74)	(73)	(72)	(71)	(70)	(6F)	(6E)
r18	- 0	(7B)	(7A)	(79)	(78)	(77)	(76)	(75)
r19	- 0	- 0	- 0	- 0	(7F) RESUME	(7E)	(7D)	(7C) WAIT

Warning and status messages

The following is a list of warning messages that may be displayed by the 2488MKII, together with a note of their possible cause, and the actions you can take when they occur.

In the messages, keys to be pressed are enclosed in brackets ([YES/ENTER] or [NO/EXIT]) and menu items are written in uppercase/capital letters (DELETE UNUSED).

No.	Message	Meaning	Action
1	Cannot do this when not stopped. Stop the transport. Press [EXIT].	The hard disk is being accessed for playback or recording, so the selected action cannot be performed.	Press NO/EXIT , stop the transport and retry the operation.
2	Cannot find digital input. Check your system set-up. Press [EXIT].	Digital audio input mode has been selected, but the 2488MKII cannot detect a valid digital audio input.	Press NO/EXIT and check the digital connection. If the connection is good, it is possible that the signal is the wrong type. The 2488MKII expects a signal in S/PDIF (IEC60958 Consumer use) format at 44.1 kHz. It cannot accept compressed audio formats, etc.
3	Can't duplicate to the same track as the source. Press [EXIT]	When editing tracks, you have selected the same track as both source and destination for a duplicate operation.	Press NO/EXIT and select a different source or destination track as appropriate.
4	Digital input is selected. Cannot do this operation now. Press [EXIT].	Because digital audio input is selected, the following functions cannot take place: Tuner, pitch and SSA functions, MTC slave operations, jog and trim functions, audio CD operations).	Press NO/EXIT and turn off digital input (the MIXER section of the PREFERENCES menu) before proceeding with the operation that produced this message.
5	Disc is already blank. Can't erase it. Press [EXIT].	An attempt has been made to erase a disc (CD-RW) that is already blank.	Press NO/EXIT and replace the disc if necessary.
6	Disc is blank. Can't finalize this disc. Press [EXIT].	An attempt has been made to finalize a blank disc (CD-R or CD-RW).	Press NO/EXIT and replace the disc if necessary.
7	File too big to import. Choose another file for import. Press [EXIT].	The selected WAV or Standard MIDI File cannot be imported into the current song as there is not enough disk space on the current partition.	Press NO/EXIT and delete a song (SONG -> DELETE) to free up space on the partition (note that this cannot be undone).
8	File too big to export. Choose another file for export. Press [EXIT].	The data selected for export to the FAT partition is too big (there is not sufficient space on the FAT partition).	Press NO/EXIT , use the USB OPEN function to manage the files (move or delete unwanted ones) on the FAT partition from a computer and retry. Alternatively, if there is no wanted data on the FAT partition, use the 2488MKII to reformat the FAT partition (all data on the FAT partition is irrecoverably lost). The maximum file size is 4 GB.

Appendix

No.	Message	Meaning	Action
9	Import file not found. Use USB OPEN to import file. Press [EXIT] .	The file selected (backup file, WAV file for import, or SMF) is not available.	Press NO/EXIT , use the USB OPEN function to transfer the appropriate file to the FAT partition and then try importing again.
10	Invalid Fs rate detected. Check your system set-up. Press [EXIT] .	Digital audio input mode has been selected, but the 2488MKII has detected the wrong sampling frequency (Fs) for the incoming digital audio to be used.	Press NO/EXIT and check the digital audio source. The output should be 44.1 kHz (note that some players output 48 kHz). A unit with varispeed (pitch control) may have varispeed turned on, altering the sampling frequency from 44.1 kHz.
11	Master track is too short. Use PRE-MASTERING to correct it. Press [EXIT] .	The master track is too short, and therefore cannot be checked.	Press NO/EXIT , re-set the OUT point to at least four seconds after the zero point, then use the PRE-MASTERING function for checking.
12	MTC slave mode selected. Cannot do this operation now. Press [EXIT] .	Since the unit is currently slaved to external MIDI timecode, the selected operation cannot take place. Operations not possible in MTC slave mode include: pitch control and SSA, repeat playback, auto-punch operations, jog and trim as well as audio CD playback and digital audio input.	Press NO/EXIT and use the menu system (SYNC/MIDI->SYNC) to select INTERNAL sync.
13	No file for import has been found. Change CD [YES] , else press [NO]	No WAV file for import has been discovered on the loaded CD.	Press YES/ENTER to change the disc (use an ISO9660 formatted disc which contains audio data with 44.1 kHz sampling frequency in WAV format) or NO to cancel the operation.
14	No free hard disk space, Use DELETE UNUSED to make space. Press [EXIT] .	The hard disk is full, and the current operation has failed because it needs hard disk space.	Press NO/EXIT and use one of the SONG menu operations such as DELETE UNUSED or ERASE to free up some space (these operations cannot be undone).
15	No LAST REC point. Use IN-OUT instead. Press [EXIT] .	Can't use the last recording point for auto punch operations, as no recording has been done yet.	Press NO/EXIT and set the IN and OUT points as the punch positions. Use the RHSL key to refine these points if necessary, by rehearsing takes without recording.
16	No locate markers have been set. Use INSERT MARK. Press [EXIT] .	Because there are no mark points currently set, a location command cannot be performed.	Press NO/EXIT , and use the INSERT key from the home screen to add some mark points at the appropriate positions.
17	No master track found. Use PRE-MASTERING to create one. Press [EXIT] .	There is no master track available for making an audio CD.	Press NO/EXIT , then use the RE-MASTERING function to create the master track.

No.	Message	Meaning	Action
18	No tracks have been armed. Arm at least one track. Press [EXIT] .	Before an auto-punch operation, you must have at least one armed track.	Press NO/EXIT and press the REC key of at least one track on which you will be recording (once a track has been armed in auto-punch, the track arming status cannot be changed).
19	Non-linear audio detected. Check your system set-up Press [EXIT] .	Digital audio input mode has been selected, but the 2488MKII has detected the wrong data format for the incoming digital audio to be used.	Press NO/EXIT and check the digital audio source. The 2488MKII expects a signal in S/PDIF (IEC60958 Consumer use) format at 44.1 kHz. It cannot accept compressed audio formats, etc.
20	Not enough free disk space. Use DELETE UNUSED to make space. Press [EXIT] .	Copying a song has failed because there is not enough space on the selected or target partition.	Press NO/EXIT and use one of the SONG menu operations such as DELETE UNUSED or ERASE to free up some space on the partition where there is not enough space (these operations cannot be undone).
21	Not enough free memory. Use DELETE UNUSED to free memory. Press [EXIT] .	Sometimes after repeated operations, the internal memory of the 2488MKII becomes used, and recording, etc. is not possible.	Press NO/EXIT . Use the DELETE UNUSED menu item from the SONG menu. As well as deleting the unused song data, this action will also free up memory, so recording can continue. Remember that this operation cannot be undone.
22	Not enough room on CD for burn. Use another CD [YES] or cancel [NO] .	Too much data has been selected to fit onto the CD that is currently loaded.	Press YES/ENTER to change the CD for another one, or NO/EXIT to cancel the current operation. Use a higher-capacity disc when burning a master track or exporting data, or one of the same capacity as the current disc when backing up.
23	Not enough room on hard disk for this operation. Press [EXIT] .	No enough space on the hard disk to create the image file necessary to create a CD.	Press NO/EXIT and create space by deleting songs, etc., (SONG->ERASE) backing them up if necessary (this operation cannot be undone). You can free up space on a partition other than the current partition (use the DISK->SELECT function) in order to create space for the image.
24	Protected song. Unprotect with SONG PROTECT. Press [EXIT] .	Recording, track editing, recording, titling, etc. cannot be carried out when the current song has been protected.	Press NO/EXIT , and use the PROTECT menu item from the SONG menu to remove the protection from the song before proceeding.
25	Repeat mode is selected. Cannot do this operation now. Press [EXIT] .	Because repeat mode is selected, the following functions cannot take place: locate operation, track editing, undo/redo, auto punch, quick routing, all menu operations, and shutdown.	Press NO/EXIT and cancel the repeat mode (REPEAT key) before proceeding with the operation that produced this message.
26	SSA mode is selected. Cannot do this operation now. Press [EXIT] .	Because SSA mode is selected, the following functions cannot take place: MTC slave operations, jog and trim functions, recording (including auto-punch) and digital input.	Press NO/EXIT and cancel the SSA mode (PITCH/SSA key) before proceeding with the operation that produced this message.

Appendix

No.	Message	Meaning	Action
27	Time between IN and OUT is too short. Re-set the points. Press [EXIT].	Repeat playback or auto-punch operations cannot be carried out because the time between the IN and OUT locate markers is too short.	Press NO/EXIT , and re-enter or edit the IN and OUT points so that the time between them is longer, before attempting the operation again.
28	Too many locate markers. Use DELETE MARK to delete some markers. Press [EXIT].	More than 999 markers have been set in the song and so a new marker cannot be entered.	Press NO/EXIT , and use the DELETE key from the home screen to delete some of the unwanted marks.
29	Too many songs to continue with this operation. Press [ENTER].	Copying a song has failed because there are too many songs already on the selected or target partition.	Press ENTER . Back up any songs you want to keep, and then use the ERASE menu item from the SONG menu to erase unwanted songs, or songs you have backed up before proceeding with the song copy (deleting songs cannot be undone).
30	Too many songs. Use SONG ERASE to delete songs you don't need. Press [EXIT].	There are too many songs stored on the current partition (the limit is 250 songs on one partition) for a new song to be created, or a song that has been backed up to be restored.	Press NO/EXIT . Back up any songs you want to keep, and then use the ERASE menu item from the SONG menu to erase unwanted songs, or songs you have backed up before proceeding with the creation or restoration of a song (deleting songs cannot be undone). Alternatively, use DISK -> SELECT to select another partition.
31	Too many takes. Can't continue recording Press [EXIT].	The repeat auto-punch procedure can't continue because more than 99 takes have been recorded.	Press NO/EXIT , stop recording, select the desired take from the list. Press ENTER and press AUTO PUNCH again, selecting a mode other than LAST TAKE LOAD. Takes recorded before this cannot be restored, so the first selection should be made carefully!
32	Track already written to disc so only 1 song can be written. Press [EXIT].	Because at least one track is already present on the disc, it is not possible to burn more than one track at once. To burn several tracks at one time (Disc At Once), you must start with a blank disc.	Press NO/EXIT and replace the disc if necessary.
33	Track is too short. Choose and set another OUT point. Press [EXIT].	The distance between the zero point and the OUT point is too short for mastering. A CD track must be at least four seconds long.	Press NO/EXIT , and re-set the OUT point to at least four seconds after the zero point.
34	Wrong type of CD. Check the disc. Press [EXIT].	The wrong type of CD for the operation has been loaded in the drive. This could be because: : A non-writable CD has been selected for writing An attempt has been made to finalize an already finalized disc An attempt has been made to erase a non- CD-RW disc. A disc which is not a backup disc has been loaded for a restore operation.	Press NO/EXIT and replace the disc with the correct type of disc for the operation.

No.	Message	Meaning	Action
35	No CD divide markers have been set. Use INSERT MARK. Press [EXIT] .	There are no marks set for the LIVE WRITER to divide the song into CD tracks	Marks can be set when the transport is stopped, during playback, and even during recording by simply pressing the INSERT key. When using the LIVE WRITER, the maximum number of usable marks is 98, and the interval between these marks must be at least 4 seconds.
36	Track is too short. Insert and trim marker to correct it. Press [EXIT] .	An interval between the marks to be used by the LIVE WRITER to divide the song into CD tracks is less than 4 seconds long.	With the transport stopped, press the TRIM key and use the JOG/DATA dial to adjust the positions of the marks so that all intervals between them are more than 4 seconds. You can also use the INSERT key to set new marks at appropriate positions. The maximum number of usable marks is 98 when using the LIVE WRITER.
37	Time between TO and FROM is too short. Re-set the points. Press [EXIT] .	The time between the FROM and TO points is too short when using the COPY FROM->TO function for track editing, so the function cannot be executed.	Set the time between the FROM and TO points to 0.5 seconds or more. The FROM and TO points can be set by pressing their respective keys while holding down the LOCATE key.
38	SMF player is selected. Cannot do this operation now. Pres [EXIT] .	This function is inoperative when using the SMF PLAYER.	Open the SMF PLAYER screen (MENU -> SYNC/MIDI -> SMF PLAYER) and set the PLAYER item to OFF.
39	No free metronome mode selected. Use METRONOME to select. Pres [EXIT] .	The metronome function is not set to FREE mode.	Open the METRONOME screen (MENU -> SYNC/MIDI -> METRONOME) and set the MODE to FREE.

TASCAM

TEAC Professional Division

2488MKII

TEAC CORPORATION

Phone: +81-422-52-5082

3-7-3, Nakacho, Musashino-shi, Tokyo 180-8550, Japan

www.tascam.com

TEAC AMERICA, INC.

Phone: +1-323-726-0303

7733 Telegraph Road, Montebello, California 90640

www.tascam.com

TEAC CANADA LTD.

Phone: +1905-890-8008 Facsimile: +1905-890-9888

5939 Wallace Street, Mississauga, Ontario L4Z 1Z8, Canada

www.tascam.com

TEAC MEXICO, S.A. De C.V

Phone: +52-555-581-5500

Campeños No. 184, Colonia Granjes Esmeralda, Delegacion Iztapalapa CP 09810, Mexico DF

www.tascam.com

TEAC UK LIMITED

Phone: +44-8451-302511

Unit 19 & 20, The Courtyards Hatters Lane, Watford, Hertfordshire. WD18 8TE, U.K.

www.tascam.co.uk

TEAC EUROPE GmbH

Phone: +49-611-71580

Bahnstrasse 12, 65205 Wiesbaden-Erbenheim, Germany

www.tascam.de
